

**RACING AND SAFETY RULES – INDEX**

APBA Rule Book Revision No. 24/1.0.....	1	511	INTERCITY RECORDS ON OCEAN COURSES .....	31
GROUP 100 – ADMINISTRATION .....	3	512	SPEED ACHIEVEMENT AWARDS .....	32
DEFINITIONS .....	3	GROUP 600 – COURSES .....		33
101 APPLICATIONS FOR AND ALLOCATION OF EVENTS .....	4	601 STANDARD CHAMPIONSHIP COURSE		
102 LICENCES .....	6	33		
103 PENALTIES .....	10	602 BUOYS .....		33
104 APBA CHAMPIONSHIP and TRIALS – REPORTS and CLAIMS .....	11	603 RIGHT OF WAY .....		34
105 REFEREES .....	12	604 OVERLAP .....		34
106 TROPHIES .....	14	605 OVERTAKING .....		35
107 CONDUCT OF MEMBERS .....	15	606 GENERAL – Sections I, O and FF .....		35
GROUP 200 – ENTRIES .....	16	607 CIRCUIT CHAMPIONSHIP COURSE DIAGRAM.....		36
201 GENERAL CONDITIONS .....	16	608 PENALTIES.....		36
202 OWNERSHIP .....	17	GROUP 700 – ENGINE MEASURING AND FUEL CHECKS .....		37
203 LODGEMENT of ENTRY .....	17	701 ENGINE MEASURERS.....		37
204 RACE NUMBERS .....	19	702 ENGINE EXAMINATION AND SEALING		
205 CREWS.....	19	37		
GROUP 300 – MANAGEMENT OF EVENTS .....	20	703 FUEL CHECKS.....		38
301 SUSPENSION of RULES .....	20	GROUP 800 – SAFETY .....		39
302 GENERAL CONDITIONS .....	20	801 DRIVER APPAREL.....		39
303 POSTPONEMENTS .....	21	802 EQUIPMENT FOR DRIVER PROTECTION		
304 INSPECTIONS and BRIEFINGS.....	21	40		
305 MANAGEMENT OF EVENTS ADDITIONAL		804 HULLS and MACHINERY .....		42
23		805 LOG BOOKS .....		44
GROUP 400 – PROTESTS AND APPEALS .....	24	806 RESCUE SERVICES.....		44
401 GENERAL.....	24	807 INCIDENT REPORTING.....		46
402 PROTESTS .....	24	808 FORMULA FUTURE DRIVER SAFETY		
403 FIRST APPEAL .....	24	ORIENTATION .....		46
404 FURTHER APPEAL .....	25	GROUP 900 – CONDUCT OF CHAMPIONSHIPS .		48
405 ADMINISTRATIVE APPEAL.....	25	901 GENERAL .....		48
GROUP 500 – RECORDS .....	26	902 START PROCEDURES and METHODS		48
501 ELIGIBLE CLASSES .....	26	903 CLOCKS.....		49
502 COURSES .....	28	904 SIGNALS .....		49
504 METHODS of TIMING .....	28	905 START .....		49
505 CALCULATION OF SPEEDS .....	29	906 RACE.....		50
506 MARGINS .....	29	907 WINNER .....		50
507 INTERVALS and INTERRUPTIONS .....	29	908 POINT SCORE TABLE .....		50
508 ELIGIBILITY TO CLAIM .....	30	909 HANDICAP RULES – .....		51
509 SPECIAL RECORD ATTEMPTS .....	30	910 RULES for CHAMPIONSHIPS		
510 WORLD RECORD ATTEMPTS.....	30	CONDUCTED as a SERIES .....		51

GROUP 1000 – REINFORCED COCKPIT RULES..53	1113 SUPERSTOCK RESTRICTED CLASS RULES ..... 66
1000 REINFORCED COCKPITS .....53	1114 SUPERSTOCK BRACKET RACING ..... 66
1001 GENERAL INFORMATION .....53	GROUP 1200 – OUTBOARD CLASS RULES ..... 67
1002 REINFORCED COCKPITS – FOR INBOARD AND OUTBOARD SECTIONS 53	1201 GENERAL ..... 67
1003 REINFORCED COCKPIT ORIENTATION 59	1202 HULLS ..... 68
GROUP 1100 – INBOARD SECTION RULES .....61	1203 MOTORS ..... 70
1101 GENERAL .....61	1204 FUEL ..... 71
1102 BOATS – GENERAL INFORMATION ....62	1205 FORMULA CLASSES ..... 72
1103 ENGINES – GENERAL INFORMATION .63	GROUP 1300 – DRAG CLASS RULES ..... 83
1104 FUEL – GENERAL INFORMATION .....63	GROUP 1400 – OFFSHORE RULES ..... 83
1105 UNLIMITED DISPLACEMENT CLASS RULES .....63	GROUP 1500 – CRUISER CLASS RULES ..... 83
1106 RACING RUNABOUT CLASS RULES....63	GROUP 1600 – FORMULA FUTURE RULES ..... 84
1107 OZ LITES 1.6 LITRE BOATING REGISTER CLASS RULES .....63	1601 CHAMPIONSHIP and TROPHY..... 84
1108 4.2 LITRE STOCK REGISTER CLASS RULES .....64	1602 GENERAL ..... 84
1109 CARBURETTORED CAST IRON DISPLACEMENT CLASS RULES .....64	1603 BOAT ..... 84
1110 PRO STOCK CLASS RULES .....64	1604 MOTOR..... 85
1111 GRAND PRIX HYDROPLANE CLASS RULES .....65	1605 SAFETY REQUIREMENTS ..... 85
1112 BLOWN LITES DISPLACEMENT CLASS RULES .....66	1606 RACING FORMAT ..... 85
	1607 CHAMPIONSHIP RACING FORMAT ... 85
	GROUP 1700 – INFLATABLE CLASS RULES ..... 86
	GROUP 1800 – VINTAGE/VETERAN RULES ..... 86
	1801 DEFINIITIONS ..... 86
	1802 STATIC (ON LAND ONLY) DISPLAY .. 86
	1803 ON WATER DISPLAY ..... 86
	1804 SAFETY REQUIREMENTS ..... 87

This publication is solely for the information and interest of members of the Australian Power Boat Association and is not available to outside bodies for any other purpose. No portion of this book may be reproduced in any form without written permission from the APBA.

**Version 24/1.0**

## Changes from 2023-2024 Rule Book

### Definitions:

Race – “on-water display” - removed

101.07	Removed - AUSTRALASIAN AND AUSTRALIAN CHAMPIONSHIP EVENTS – These must be conducted before 1 July each year. Events conducted as a series are exempt from this requirement.
404.012	Delete dollar value and add “as set annually by the National Council”
405.014	Delete dollar value and add “as set annually by the National Council”
405.015	Delete dollar value and add “as set annually by the National Council”
801.012	Additional paragraph added for PFD’s in open Cockpit boats
801.03	Helmet section amended plus additional dot point for clarification.
802.05	Change disqualified to “may be issued with a Yellow Card” Change Repeat Offences to “will be issued” Plus additional dot point for parade lap.
1102.31	Wings – allowance for all forced induction boats.

# GROUP 100 – ADMINISTRATION

## DEFINITIONS

- 101 APPLICATION FOR AND ALLOCATION OF EVENTS
- 102 LICENCES
- 103 PENALTIES
- 104 APBA CHAMPIONSHIP and TRIALS – REPORTS and CLAIMS
- 105 REFEREES
- 106 TROPHIES
- 107 CONDUCT OF MEMBERS

## DEFINITIONS

<b>Annual General Meeting</b>	means the Annual General Meeting of The Association
<b>Annual Meeting</b>	means the meeting of The Association held in conjunction with the Annual General Meeting
<b>The Association</b>	means the Australian Power Boat Association, the Council of the Australian Power Boat Association and the Executive of the Australian Power Boat Association
<b>APBA Official</b>	means a person appointed by The Association or a Council to act in an official capacity
<b>Official</b>	means a person appointed by a Club to act in an official capacity
<b>Boat Owner</b>	means a person holding a current competition boat owner licence issued by a Council
<b>Crew Member</b>	means a person recognised as providing assistance to, at the request of, a Driver or Boat Owner during an Event
<b>Club</b>	means a Member Club of The Association
<b>Council</b>	means a Member Council of The Association
<b>Driver</b>	means a person holding a current competition driver licence issued by a Council
<b>Riding Crew</b>	means a person who travels in a Boat during a race but who is not directly responsible for the control of the boat
<b>Event</b>	means an approved race, races or race meeting conducted by The Association, a Council or Club on a day or over a weekend with the Sanction of The Association, for the purposes of Licence signatures and endorsements an event is any race meeting held on consecutive days at one venue is deemed as one (1) Event
<b>Race</b>	means any race, heat, final or other competition conducted within an Event
<b>Secretary</b>	means the Secretary of The Association
<b>Licence</b>	means a Driver or Boat Owner competition licence issued by a Council entitling a person to compete in an Event
<b>Licence Year</b>	means the year of competition and Licence duration commencing 1 September each year and expiring 31 August of the follow year
<b>Officer of the Day</b>	means a person appointed by The Association, a Council or Club to act in the highest official capacity throughout the conduct of an Event
<b>Rules or Rule Book</b>	means the book of administration, racing and safety rules issued or published periodically by The Association
<b>Championships</b>	means championship races, whether Australasian, Australian or State, contested between boats complying with the rules of various classes as listed in the Rule Book
<b>Speed &amp; Time Trials</b>	means trials for the establishment of speed records or time records, whether Australasian, Australian or State, attempted by boats complying with the rules of various classes as listed in the Rule Book
<b>State Referee</b>	means a person, having met the requirements of the Rules, appointed by a Council

	to act as a Referee during Events in accordance with the Rules
<b>Australian Referee</b>	means a person, having met the requirements of the Rules, appointed by The Association to act as a Referee during Events in accordance with the Rules
<b>Race Committee</b>	means a Committee appointed by The Association, a Council or Club to organise and oversee the conduct of an Event
<b>Section</b>	means a particular section or division of powerboat racing, i.e.: Inboard, Outboard, Drag, etc
<b>Class</b>	means a particular division or class of powerboat within a Section based on hull design, engine capacity, modifications or a combination thereof, i.e.: Unlimited Displacement, 6000cc Naturally Aspirated Displacement, etc
<b>Pit Area</b>	means an area or areas designated for the storage, repair, refuelling, launching and retrieval (and other associated activities) of race boats during an Event. The Pit Area may be a secured, semi-secured or open area depending on local circumstances
<b>Briefing</b>	means any meeting of Drivers, Riding Crew and/or Boat Owners at an Event called by the Officer of the Day or Official for the purposes of conveying race instructions, carrying out breath testing and discussion between these parties of any matter pertaining to the Event
<b>Scrutineering</b>	means the inspection of any Boat by Officials prior to or during the conduct of an Event in order to ensure compliance with the Rules
<b>Boat</b>	means a boat (including hull, engine/s and rigging) entered by a Boat Owner for competition at an Event. Such Boat must comply with the Rules of The Association and the Rules of the Section and Class entered
<b>Reinforced Cockpit</b>	means a containment area for Driver and Riding Crew, as approved by The Association, constructed and fitted to a Boat in accordance with the Rules in order to provide protection to the Driver and Riding Crew
<b>SBA</b>	means the State Boating Authority established by each State Government and responsible for boating activities in each state
<b>Inboard</b>	means a Boat with the engine unit wholly contained within the confines of the hull
<b>Outboard</b>	means a Boat with the engine unit attached to the outer part of the transom of the hull
<b>Displacement</b>	means a Boat of displacement or monoplane type in which the continuity of the portion of the hull is immersed at rest
<b>Hydroplane</b>	means a Boat where the immersed portion of the hull is divided into two or more distinct planing surfaces by a transverse or longitudinal (or both) step or steps
<b>Naturally Aspirated</b>	means an engine in which air intake depends solely on atmospheric pressure and which does not rely on forced induction through a turbocharger or a supercharger.
<b>Lane</b>	all courses shall be divided into lanes. The lanes, numbered 1, 2, 3 and so on from closest to the turn buoys/infield and moving outward, shall be applied to turns and straights alike.
<b>physical outside assistance</b>	actual touching of a race boat during the race by any means by anyone other than the driver.

## **101 APPLICATIONS FOR AND ALLOCATION OF EVENTS**

101.01	<b>RACE CALENDAR</b> – Each Club must submit to its Council a list of proposed Events and venues for approval before 1 May of each year.
101.011	If the proposed Event is in a state other than the state that the Club is affiliated, the application must be submitted to the Council in which the Event is to be conducted for approval and sanction.
101.02	Each Council must prepare a calendar of proposed Events and forward this calendar to the Secretary 1 May of each year.
101.021	At the June meeting of The Association each Council's proposed Events will be tabled for approval. The Association's approval will be granted subject to the agreement of a majority of Councils represented at the meeting if there is a clash of major Events on any date.
101.022	A calendar of Australasian, Australian, and State Championships, and approved Club Events will be published by The Association.
101.023	Except with the consent of The Association, no Event will be sanctioned in Australia which falls on

the same date, including the day before or day after, as an Australasian Championship, Drag Class National Championship, Australian Unlimited Open Championship or any Event which The Association deems of significant importance.

101.03 Following the publication of the calendar, any application to conduct an Event not included in the published calendar, with the exception of World Record Attempts, Speed and Time Trials, or Special Record Attempts, must be made to the Council in which the Event is to be conducted. If approved by the Council, the Secretary must be notified of such approval before such Events are deemed to be "Sanctioned".

101.031 A Council may withdraw sanction from an Event at any time, but only with the concurrence of the Association.

101.04 All Clubs and/or Councils must notify all other Councils at least four (4) weeks before the conduct of any Event applied for under Rule 101.03 particularly Championships as competitors from any state are eligible to enter State Championships in another state and are therefore entitled to prior notification.

101.05 **WORLD RECORD ATTEMPTS, SPECIAL RECORD ATTEMPTS AND OPEN SPEED OR TIME TRIALS**

Applications for such Events must be made in writing to the Council in which the Event is to be conducted at least four (4) weeks before the date of the Event. Such applications, if applicable, must include the information requested in Rule 509 – Special Record Attempts and Rule 510 – World Record Attempts.

101.06 If approved by the Council, notification must be given in writing to the Secretary of any such application not less than two (2) weeks prior to the proposed Event.

**101.07 Removed**

101.08 The Association will allocate all Australasian and Australian Championships at the Annual Meeting.

101.081 The Council to which Championships are allocated is responsible for the conduct of the Championships in their entirety but may delegate all or part of such responsibility to a Club or Clubs.

101.082 When conducted in Australia, The Association will control the Australasian Inboard Championships namely the E. C. Griffith Cup, Marjorie Watson Trophy and A. E. Baker Trophy. The Association will allocate these Events to the Councils, Clubs and/or organisations that offer the greatest benefits/exposure for the sport based on a formal submission of interest process.

101.083 When practicable, Australian Championships are to be allocated the same date and venue each year or as determined by The Association.

101.084 Any Club granted Australasian or Australian Championship/s, must provide, as minimum, suitable accommodation for Officials of The Association required to attend. These officials may include Australian and State Referees and (if required) Engine Measurers.

101.085 **AUSTRALIAN OFFSHORE CHAMPIONSHIP EVENTS** will be allocated with the approval of the Offshore Council. The Offshore Council is responsible for the conduct of the Championship events but may, by agreement, delegate all or part of such responsibility to an affiliated Offshore Club or Clubs. If any responsibility is delegated to a Club, the Race Committee must include a representative appointed by the Offshore Council.

101.09 If, in advance of the Annual Meeting, no Council applies to conduct a particular Championship, Councils may apply from the floor at the Annual Meeting for a particular unallocated Championship.

101.10 The format of Australian Championships will be at the discretion of The Association.

101.11 For the purpose of Australasian Championships, and Speed Trials, Clubs and affiliated members of the New Zealand Power Boat Federation Inc. will be regarded as a Club of The Association.

**101.12 CATEGORIES OF EVENTS**

**Category 1 (C1)** Only Drivers holding a Full Licence may compete. These are: - Australasian, Australian or State Championships, Speed Trials, Time Trials or Major/Spectacular days as designated by conducting Clubs at time of sanction.

**Category 2 (C2)** The Club defines races in which holders of Probationary Licences may compete. Alternatively, they may define Special Events in the programme requiring a Full Licence.

These are: Events with specified major races or combination of major races, Championship Series rounds, etc., with lower level races.

**Category 3 (C3)** Open to all licence types. These are: - Club Events and Interclub Events.

101.121 Each Club must nominate the category of Events when applying for sanction. Ultimate sanction rests with the relevant Council.

101.13 Where a C1 and C2 category Event has prize money payable on finals run and listed, the Club or Council conducting the Event is to advise The Secretary or Council secretary and competitors (if requested) seven (7) days before the event being held. The listing must also be presented to competitors at Scrutineering. Failure to pay advertised prize and/or tow money on events/races will

result in a suspension of future sanctions.

101.14 UIM EVENTS – Any UIM Event conducted in Australia by an entity other than a Club, Council or The Association will be subject to a Calendar Fee as determined by The Association.

101.141 The Calendar Fee will be reviewed and set annually by The Association at the meeting referred to in Rule 8.4.2 of The Association.

## 102 LICENCES

102.01 Drivers and Boat Owners in any Event must be in possession of an appropriate Licence.

102.02 Application Forms for Licences are available to any financial member of a Club from the respective Club or Council.

102.03 Completed applications must be forwarded to the Council in the state of applicant's residential address.

102.031 Licences issued for Offshore must be forwarded to the Secretary of the Offshore Council.

102.04 A completed application must include:

- Boat Owner Form and/or Competition Licence Form
- A Current Medical Examination Form as required by Rule 102.30 (except for Day, Novice or Formula Future Licences which require Self-Assessing Medical Declaration)
- Proof of Financial Membership of a Club
- Evidence of driving history as required by these Rules
- The prescribed fees for Licence

102.05 All Licences (except Day, Novice and Single Event) are valid up to the 31st August of each year. Novice and Day Licences are valid only for the day of issue.

Single Event Licences are valid only for the single Event issued.

102.06 Any Boat Owner or Driver owing money to The Association or being in default of the return of a perpetual trophy will:

- not be permitted to renew their Licence until such time that the outstanding matter is finalised
- have their Licence suspended by The Association until the outstanding matter is finalised.

102.07 Each Council Secretary or Licence Officer must maintain a record of Licences issued or renewed each year. Such record must contain details including, but not limited to: Date of Issue of Licence; Licence and/or Race Number issued; the Licence Holders' Name, Address, Date of Birth, Contact numbers, email address and Club / Class Endorsements (*i.e.* "I", "D", "OH", *etc.*), Licence Grade (*i.e.* *Unlimited, Limited, Restricted*) and Category of Licence (*i.e.* *Full, Probationary, etc*)

102.071 Each Council must provide, no later than the 7<sup>th</sup> day of each month, a copy of its record of Licences to The Secretary.

102.08 The Association will maintain a record of Licences issued or renewed each year, Australia-wide.

102.09 The fee for each Licence will entitle any person to a Licence, Rule Book and free entry (post entries excluded) to Championships and Speed & Time Trials.

### 102.10 LICENCE CLASS ENDORSEMENTS

102.101 Licences must be endorsed signifying each Class of Boat the Driver is experienced in handling under racing conditions as follows:

<b>I</b>	Inboard DISPLACEMENT Classes	<b>OS</b>	OFFSHORE Classes
<b>O</b>	Outboard MONO/MOD-VP Classes	<b>FF</b>	FORMULA FUTURE Classes
<b>IH</b>	Inboard HYDROPLANE Classes	<b>P</b>	INFLATABLE Classes
<b>OH</b>	Outboard HYDROPLANE Classes	<b>JS</b>	JET SKI Classes
<b>D</b>	DRAG Classes	<b>F1</b>	F1 Commission Licences

102.102 All licences for sections I, O, IH, OH, FF and JS can be endorsed for section D.

102.103 Endorsements (as listed on the Applicants Licence Form) are to be made in the endorsement section of the Licence by the Council Licence Officer or Council official.

**102.11 LICENCE GRADES**

Licences will be endorsed to limit or designate the class of Boat the Driver is eligible to drive in competition. The grades are as follows:

	<b>INBOARD</b>	<b>DRAG</b>	<b>OUTBOARD</b>	<b>OFFSHORE</b>	<b>FORMULA FUTURE, INFLATABLE &amp; JETSKI</b>
<b>UNLIMITED</b>	GP Hydroplane. Boats with an engine capacity of over 6000cc	TFH, BAH, BHL, LHO, BAD, BAF, LAD, UOB and UOM	All sponsored Boats with engine capacity over 2100cc	Class 1 & Supercat 1000	
<b>LIMITED</b>	All Classes other than those categorised as Unlimited	All Classes other than those categorised as Unlimited	All Classes other than those categorised as Unlimited	All Classes other than those categorised as Unlimited	All Inflatable Classes
<b>FORMULA FUTURE</b>		All Formula Future Classes			All Formula Future Classes
<b>VINTAGE/VETERAN</b>	V/V ONLY	V/V ONLY	V/V ONLY	V/V ONLY	

**102.12** Unlimited and Limited Drivers are automatically endorsed for the Vintage/Veteran Class

**102.20**

**LICENCE CATEGORIES**

**102.21**

**PROBATIONARY DRIVER LICENCE**

- All new Licences issued are Probationary until the Driver obtains the signatures of a Referee, Officer of the Day, or an APBA Official, after competing in a minimum of four (4) races over a minimum of two (2) Events.
- The signatures must not all be obtained from the same Official.
- The signatures must be provided by the Official only if the Official is satisfied that the Driver has displayed adequate skill and demeanour.
- Signatures are required for each endorsed class. Once the required signatures have been obtained, the Licence is regarded as Full.
- Drag, Formula Future, Jet Ski and Offshore Sections are exempt from this requirement.
- Drivers holding a Probationary Licence are not permitted to compete in any Speed & Time Trial Event or Championship unless the championship is conducted as a series
- Drivers holding a Probationary Licence must start each race in the outside lane and must maintain that position until after completion of the first turn.
- Drivers who have not competed for a two (2) year period will return to Probationary status until the Driver meets the requirements of Rule 102.22.
- Drivers must have their Rule Book signed by an Official at a minimum of two (2) Events per Licence Year in order to maintain a Full Licence.

**102.22**

**FULL DRIVER LICENCE**

- Are Licences renewed with two (2) signatures for each endorsed class, from two (2) Events in the previous Licence year and are indicated as a Full Licence from the Council Licence Officer.
- The signatures must be provided by the Official only if the Official is satisfied that the Driver has displayed adequate driving skill and demeanour.
- Any Class category with less than two (2) signatures will be regarded as Probationary until the required signatures are obtained.
- Clubs or Councils may nominate particular events as Category 1 Event as a safety measure, to restrict entries to Full Licences having two (2) signatures. This must be noted on any advance information.

**102.23**

**BOAT OWNER LICENCE**

- Application for Boat Owner Licence must be made on the specified form to the Council in the state of applicant's residential address.
- Boat Owners must be a financial member of a Club.
- Boat Owners are required to obtain and hold current Rule and Log books.
- In instances where Boat Owner owns more than one Boat, separate Rule Books and Log Books are to be issued by the owners' Member Council.

- The Council must also issue separate Race Numbers for each Boat.
- The Association will review Boat Owner Licence fees annually.
- A Boat Owner Licence will entitle the member to free entry (post entries excluded) to Championships, Speed & Time Trials
- Boat Owner Licences are to be endorsed signifying the grade the Boat for which they apply. The grades of Boats are set out in Rule 102.011.
- Where a Company is the registered Boat owner, the applicant applying for the Boat Owner Licence must be a Director of the Company and must be a financial member of a Club. Confirmation of directorship must be provided in the form of an ASIC Company Search.

#### 102.24

##### **DAY LICENCE**

- Can be issued at the discretion of the respective Council and are intended to encourage the entry of **former** Drivers back to the sport.
- Are valid only for competition at one (1) Event.
- A Driver can obtain only two (2) Day Licences in any one Licence year.
- Are not valid for competition at a Category 1 Event.
- Require the use of the Self-Assessing Day Medical Declaration.
- Can be upgraded to a Full or Half-Year Licence.

#### 102.25

##### **NOVICE LICENCE**

- Can be issued at the discretion of the respective Council and are intended to encourage the entry of **new** Drivers.
- Are valid only for competition at one (1) Event.
- A Driver can obtain only two (2) Novice Licences before being required to obtain a Full or Half-Year Licence.
- Are not valid for competition at a Category 1 Event.
- Require the use of the Self-Assessing Novice Medical Declaration.
- Must not to be issued to any Driver that has previously held any type of APBA Driver Licence.
- Can be upgraded to a Full or Half-Year Licence.

#### 102.26

##### **SINGLE EVENT LICENCE**

- Can be issued at the discretion of the respective Council to a Driver that held a Full Licence in the previous Licence year. Proof of having held such Licence must be provided by the Driver.
- Are valid only for competition at one (1) Event.
- Requires the Driver to obtain a current Medical Examination Form.
- Cannot be upgraded during Licence year - only additional Single Event Licences can be purchased.

#### 102.27

##### **FORMULA FUTURE LICENCE**

- Are valid only for competition in the Formula Future classes as recognised or approved by The Association.
- Drivers may only compete in Formula Future Events where permitted by the relevant SBA. Formula Future Drivers must be a minimum age of eight (8) years old and maximum age of sixteen (16) years old at the time of issue of the Licence.
- A Formula Future Driver that turns seventeen (17) years old during a Licence year will be permitted to continue to compete for the remainder of that Licence year.
- Formula Future Drivers must produce a photocopy of a birth certificate or an extract of a birth certificate or a copy of current SBA Licence before being issued with a Licence.
- Formula Future Drivers will be required to fill out a Self-Assessing Formula Future Medical Declaration (22J). This form will need to be signed off by the Driver's parent or guardian.

#### 102.28

##### **VINTAGE/VETERAN LICENCE**

- Are valid only for demonstrations in the vintage/Veteran classes as recognised or approved by The Association.
- Require the use of the Self-Assessing Medical Declaration at each event where they perform an On-Water demonstration.

#### 102.29

##### **HALF-YEAR LICENCE**

Can be issued at the discretion of the respective Council and can only be issued after 1st March each Licence year. A Half-Year Licence will comply with all other terms and conditions of a Full Licence.



## **102.30 MEDICAL EXAMINATION**

- 102.31 Drivers applying for a Licence (excluding Novice, Day and Formula Future Licences) must produce a Medical Examination Form (Form 22) signed by a Medical Practitioner each Licence year. The Medical Examination Form will remain valid for the duration of that Licence year only.
- 102.32 A Medical Examination accepted by another organisation (e.g. Ski Racing Australia, CAMS or Australian Defence Forces) that is of equivalent or higher standard than The Association Medical Examination will be accepted.
- 102.33 Drivers must have an eyesight test and, where necessary, must wear spectacles if eyesight requires the wearing of spectacles under normal conditions.
- 102.34 **MEDICAL CLEARANCE TO RACE** – A Driver that has an accident or suffers from an illness or disability during the currency of the Certificate of Fitness must produce a Medical Clearance To Race Form (Form 23a) as deemed necessary by the Driver's Council Licence Officer or APBA Official.
- 102.35 The Council Licence Officer has the power to request that a Driver's Licence Book and/or Rule Book be returned to the Council after any such incident or illness.
- 102.36 A Medical Clearance to Race Form must be completed by the Driver and a Medical Attendant or Doctor before the Licence Officer or Council can reinstate the Licence. A Driver may use his or her own doctor, or a Doctor nominated by the Council following such accidents, disability or illness.

## **102.40 DEMOTION OF LICENCE**

- (a) Should a Driver holding a Full or Half-Year Licence have three (3) or more driving infringements recorded their Licence status will immediately revert to Probationary.
- (b) Should a Driver holding Probationary Licence have two (2) or more driving infringements recorded all endorsements under Rule 102.22 will be immediately cancelled and the Licence will remain a Probationary Licence until the requirements of Rule 102.22 are again met.

## **102.50 AGE RESTRICTIONS**

- 102.51 Drivers must be no less than sixteen (16) years old at the time of applying for a Licence with the exception of Drivers in the following Sections and Classes:
- Offshore (OS) Classes – Drivers and Riding Crew must be a minimum age of eighteen (18) years old
  - Drag (D) Classes – Drivers must be a minimum age of sixteen (16) years old with the exception of Drivers competing in the Blown classes, who must be a minimum of eighteen (18) years old
  - Formula Future (FF) Classes – Drivers must be a minimum age of eight (8) years old and maximum age of sixteen (16) years old at the time of issue of the Licence.
  - Inboard (I & IH) and Outboard (O & OH) – Drivers must be a minimum of sixteen (16) years old with the exception of Drivers competing in the following classes, who must be eighteen (18) years old:
    - Grand Prix Hydroplane
    - Unlimited Displacement
    - Unlimited Hydroplane
    - Unlimited Unblown Displacement
    - Blown Lites
    - Unlimited Outboard
    - Unlimited Mono

- 102.52 Where State Boating Authorities allow, Drivers of 14 years of age and over, together with a minimum of 2 years competition in the J3 class, may progress to the 25hp & Formula 4 Classes after applying for and being accepted for a licence upgrade by a State Committee of APBA in accordance with Rule 102.20. Drivers to attain Full Licence with Cell Testing for Formula 4

## **102.60 CLASS RESTRICTIONS**

- 102.61 Prior to participating in the following Classes, Drivers holding a Full Licence must have their Rule Book signed by an Official following the display of adequate driving skill and demeanour in a minimum of four (4) races conducted at a minimum of two (2) Events:
- Grand Prix Hydroplane
  - Unlimited Displacement
  - Unlimited Hydroplane
  - Unlimited Unblown Displacement
  - Blown Lites
  - Unlimited Outboard
  - Unlimited Mono

- 102.62 Prior to participating in the abovementioned Classes, Drivers not yet holding a Full Licence must have their Rule Book signed by an Official following the display of adequate driving skill and demeanour in a minimum of **four (4)** races conducted at a minimum of two (2) Events.
- 102.63 Drivers who have previously held a Full Licence, but which has lapsed **within the last three (3) years** are permitted to compete in any of the abovementioned Classes that they have previously obtained endorsement for subject to the provisions of Rule 102.22.

## **103 PENALTIES**

### **103.00 FINES**

The unit value of a Fine will be determined at the Annual Meeting. The amount of the Fine must never be less than one unit. The Association has the power to decide the amount of the Fine. Fines must be paid to The Association. Failure to pay a Fine will incur further penalty as set out in the Articles and Rules.

For the 2019/2020 Season – One (1) Unit is equal to \$550 (inclusive of GST).

### **103.01 Typical Fines include, but are not limited to;**

<b>Undue change of date</b>	<b>5 units</b>
<b>Late sending of documents</b>	<b>2 units</b>
<b>Late sending of Licence lists</b>	<b>1 unit</b>
<b>Failure to return a Trophy</b>	<b>1 unit</b>
<b>Failure to notify National Safety Officer of issue of Yellow Card within 28 days</b>	<b>1 unit</b>

103.02 Should a transgression not have a penalty specified in the Rule Book, one or more of the penalties described in the following Rules can be adopted. Although impossible to specify all the penalties that can be pronounced there are certain defined penalties, which are;

**103.03 BLAME** – Adjudgment of an action resulting in a reprimand, which can be the first step of a more severe penalty if the offence is repeated.

**103.04 YELLOW CARD** – Any Driver, Riding Crew or Boat Owner who commits a breach of the Rules where the offence is not considered serious enough to warrant either declassing, disqualification, suspension or is not covered by an existing penalty, may be issued with a Yellow Card warning.

Yellow Cards can only be issued by the Officer of the Day (as spokesperson for the Club & Race Committee) or via representation by an APBA Official to the Officer of the Day.

103.041 If two (2) Yellow Cards are issued at any Event, the Driver, Riding Crew and/or Boat Owner will be issued with a Red Card, except for fail of breath test as this is covered in Rule 201.09.

103.042 Yellow Cards remain in force for a period of twelve (12) months from the date of issue.

103.043 If issued by a Club, the Club must provide written advice to the respective Council of any Yellow Cards issued within fourteen (14) days of issue.

103.044 The Driver, Riding Crew or Boat Owner must be provided with written advice from the Council within twenty-one (21) days of the issue of a Yellow Card.

103.045 The Council must then provide written advice to the Association within twenty-eight (28) days of any Yellow Card being issued.

**103.05 RED CARD** – Any Driver, Riding Crew or Boat Owner issued with three (3) Yellow Cards within a twelve-month period will automatically receive a Red Card from The Association.

103.051 A Red Card entails automatic Suspension of the Driver, Riding Crew or Boat Owner Licence for a period of three (3) months from the date of issue of the third Yellow Card.

103.052 The Association will provide written advice to the Driver, Riding Crew or Boat Owner, the Driver, Riding Crew or Boat Owner's Club and Driver, Riding Crew or Boat Owner's Council of the issue of a Red Card. Such notification will include a request for the Driver, Riding Crew or Boat Owner to return their Licence Book to their Council.

103.053 The Association's Safety Officer is to maintain a register of Yellow and Red cards issued and will send regular updates to The Association and Councils.

103.054 Yellow and Red Cards can only be appealed via the Administrative Appeal process (Rule 405).

**103.06 DECLASSING** – The Officer of the Day may declass (i.e. to move down one place in classification) any Driver, Riding Crew or Boat Owner who during an Event, has unwittingly committed a breach of the Rules.

103.061 Any Driver, Riding Crew or Boat Owner declassified in a Race must be notified by an Official without undue delay.

103.062 An Official can only enforce declassing up to one hour following the completion of the Event.

**103.07 DISQUALIFICATION** – The Officer of the Day may disqualify any Driver, Riding Crew or Boat Owner

- who, during an Event, has committed a breach of the Rules. Zero points are to be received for the Race during which the breach was committed.
- 103.071 Any Driver, Riding Crew or Boat Owner disqualified from a Race, must be notified by an Official without undue delay.
- 103.072 An Official can only enforce disqualifications up to one hour following the completion of the Event.
- 103.08** **SUSPENSION** – The Officer of the Day may suspend a Driver or Boat Owner from an Event during which an offence has been committed.
- 103.081 A Driver or Boat Owner who has knowingly committed a breach of the Rules may be suspended.
- 103.082 Any Driver or Boat Owner suspended from an Event must be notified by an Official without undue delay.
- 103.09** **PROLONGED SUSPENSION** – The Association or a Council may pronounce a prolonged suspension on any Driver, Boat Owner, Club or other class of Member who has committed a serious moral or sporting offence.
- 103.091 The Driver, Boat Owner, Club or Member suspended is not permitted to take part in any competition for as long as the suspension lasts.
- 103.092 Any Driver, Boat Owner, Club or Member under a prolonged suspension must hand in their Licence to The Association or Council who will return it only after the suspension has expired.
- 103.10** **EXCLUSION** – Any Driver, Boat Owner, Club or other class of Member who has committed a gross moral or sporting offence is subject to exclusion.
- 103.101 Exclusion is permanent and national by definition.
- 103.11** **DISBARRING** – Any Driver, Boat Owner, Council, Club, member of the one or other, or any Official or member of The Association who brings a motor boating dispute before a civil court can be disbarred immediately from The Association.
- 103.111 If the action is instigated by a Club, the Club and all its members can be disbarred.
- 103.112 If the action is instigated by a Council, the Council including all Clubs it represents and their members can be disbarred.

## **104 APBA CHAMPIONSHIP and TRIALS – REPORTS and CLAIMS**

- 104.01 Complete details of all Australasian & Australian Championships & Series, Speed & Time Trials, Special Record Attempts and Special Australian Events, signed by the appropriate Officials **must** be lodged by the Club or Council responsible for the conduct of the Event, with the respective Council Secretary within fourteen (14) days of the Event.
- 104.02 When Australasian or Australian Championships & Series, Records or Speed Awards are being claimed, the Council Secretary **must** ensure that all documents are received by The Association Recording Secretary within twenty-eight (28) days of the event.
- 104.021 For Australian Championships conducted as a Series, the Council responsible for the conduct of the Series **must** ensure that all documents are received by The Association Recording Secretary within twenty-eight (28) days after the final round of the series.
- 104.03** Council Secretary's checklist for the complete details of all Australasian & Australian Championships & Series, Speed & Time Trials, Special Record Attempts and Special Australian Events.
- These Documents **must** be forwarded to the Association Recording Secretary.
- Referees' Reports
  - Timing Sheets (Speed & Time Trials)
  - Running Sheets (Championships/ Series & Special Events)
  - Claim Forms (one for EACH Championship place, Record or Speed Award claimed)
  - Engine Measurement Certificates (where required and available)
  - Certificate for Watches (where required)
  - Entry Forms
  - Scrutineering Forms
  - Money for Duplicate Certificates (when required)
  - Protests and written results of Protests
- 104.04 After approval, The Association Secretary will arrange for the forwarding of any certificates to the respective Council for distributing to the Driver and/or Boat Owner.
- 104.05 The onus is on the Driver and/or Boat Owner to complete the claim form and to comply with the Rules concerning engine sealing and measurement, and for the correctness of the information given on the claim form.

- 104.06 A certificate for each record and for first, second, and third place in each Championship or special event will be supplied at no cost to the Driver and/or Boat Owner if claimed. Additional copies of the certificate can be obtained by application (on claim form) at a cost of \$5 each.
- 104.07 Official Certificates for State Events are the responsibility of the respective Council.
- 104.08 Notification of a new State Record must be forwarded to The Association Recording Secretary within twenty-eight (28) days of the event, by the respective Council Secretary.
- 104.09 Councils are to be advised at least annually of current Speed and Time Records, and Championship Holders.

## **105 REFEREES**

### **105.00 ELIGIBILITY AND APPOINTMENT OF STATE REFEREE**

- 105.01 To be eligible for appointment as a State Referee, a person must have actively served for at least twelve (12) months on the Race Committee of a Club.
- 105.02 The Club will then recommend to the respective Council that the applicant is of a suitable standard and capable of refereeing at Events conducted in that state.
- 105.03 A State Referee may be required to sit and pass an examination on Group 100 to 600 and Group 900 Rules and any other rules decided by the Council Rules Officer, who will be responsible for the examination.
- 105.04 If the applicant is successful, confirmation of the appointment will take place the next General Council Meeting of the respective Council.
- 105.05 A State Referee will hold office for 12 months and on recommendation from the Council as having been reasonably active in the capacity as State Referee during that period, can be reappointed for a further 12 months without examination.
- 105.06 A State Referee is entitled to receive a copy of the Rule Book annually, at no charge. Such Rule Book is to be provided by the respective Council.
- 105.07 A list of State Referees approved for reappointment must be provided to The Association by 30 June each year.

### **105.10 ELIGIBILITY AND APPOINTMENT OF AUSTRALIAN REFEREE**

- 105.11 To be eligible for appointment as an Australian Referee, such persons must be a member of the Executive of The Association, Council or a Club.
- 105.12 The applicant must have served actively for a minimum of two (2) years as a State Referee and must have carried out refereeing duties at a minimum of three (3) Championship or Trial events before being recommended by the respective Council.
- 105.13 An application by a Council for a State Referee to sit an Australian Referee examination is to be forwarded to The Secretary and must include:
1. The name of Candidate
  2. A list of the three (3) events giving:
    - a. Type of event - e.g. Championship, Speed Trial or Time trial
    - b. Duty performed - e.g. Course Referee, Scrutineer, tower crew, etc.
  3. Preferred date and time of examination
  4. Venue
  5. Names of Supervising Officials
- 105.14 States with less than two (2) Australian Referees for the previous two years may submit their most experienced State Referee to sit an Australian Referee Examination.

### **105.20 EXAMINATION AND APPOINTMENT OF AUSTRALIAN REFEREES**

- 105.21 Examinations will be set by The Association Rules Officer and will be on general rules and specific class rules for Inboard, Outboard, Drag, Formula Future and any other specific rules applicable to the state from which the applicant will operate.
- 105.22 The format of the examination is at the discretion of The Association Rules Officer and can be either open book, closed book or multiple-choice or a combination.
- 105.23 The examination will be conducted in the presence and under the supervision of two (2) APBA Officials who must be present during the entire examination. At least one of the APBA Officials present must be a member of the Executive of The Association and the other an Executive Officer of the respective Council.
- 105.231 If for geographical reasons it is not possible for a member of the Executive of The Association to be present at the examination then two (2) Executive Officers of the respective Council will be acceptable.
- 105.24 The examination paper will be forwarded to the Council Secretary and must not be opened until the examination is due to commence.

- 105.241 On completion of the examination, all papers must be immediately returned, without perusal, to The Association Rules Officer for marking.
- 105.25 The Association Rules Officer will recommend applicants, having passed the examination, to The Association for appointment as an Australian Referee.
- 105.26 The Council will be notified of the appointment of an applicant and suitable acknowledgment of appointment will be forwarded for presentation.
- 105.27 An Australia Referee is entitled to receive a copy of the Rule Book annually at no charge. Such Rule Book is to be provided by The Association.
- 105.28 Once appointed, an Australian Referee is deemed to be qualified to referee any Event and be capable of instructing Referees in their respective duties, and if required, be capable of delivering a lecture on racing rules and procedures to any Club.

**105.30 AUSTRALIAN REFEREES - GENERAL INFORMATION**

- 105.31 The total number of Australian Referees at any time is not to exceed forty (40).
- 105.32 It is the responsibility of each Council to ensure that there are sufficient Australian Referees in the respective state to conduct Australasian or Australian Events.
- 105.321 There must be at least one (1) Australian Referee present at every Australasian and Australian Championship, Speed & Time Trial, and Special Record Attempt. The Australian Referee must always be considered as the senior Referee.
- 105.322 The Senior Referee, Assistant Referee and Course Referees are appointed by the respective Council.
- 105.33 A qualified Australian Referee will hold office for a period of twelve (12) months on the recommendation from a Council to The Association.
- 105.34 The Council should be satisfied that the Australian Referee has been reasonably active during that period, and if so they can be reappointed for a further twelve (12) months without examination.
- 105.35 An Australian Referee may be re-examined every two years.
- 105.36 A list of Australian Referees approved for reappointment must be provided by the respective Council to The Association by 30 June each year.

**105.40 RESPONSIBILITIES OF THE REFEREE**

- 105.41 All Referees are to present themselves to the Officer of the Day at least one (1) hour before the advertised start of the Event.
- 105.42 The Officer of the Day will act as liaison between the Senior Referee and the Race Committee.
- 105.43 The Senior Referee must not act as a member of the Race Committee, or any other Committee in connection with the Event. The control of a Event is in the hands of the Race Committee.
- 105.44 The Referee, whilst rendering assistance to the Race Committee, must never assume the responsibilities belonging to the Race Committee or other Officials conducting the event.
- 105.45 Suggestions made by the Referee to the Race Committee regarding the course, conduct of the event, inspections, or compliance with the Rules must be observed.
- 105.46 A Referee's role is not to find fault, but to prevent errors if possible and help to ensure the Event runs without incident.

**105.47 A REFEREE MUST:**

- Be conversant with the Rule Book and Deed of Gift for the Event and have a copy of the current Rule Book on hand for reference.
- Be conversant with any SBA, Local Government Regulations or Local Rules in relation to the conduct of the Event for the particular area.
- Attend any Briefing and be satisfied that all instructions given, and any questions asked to have been satisfactorily explained and answered.
- Attend Protest Hearings. The Senior Referee may only offer advice at Protest Hearings and cannot vote on the outcome of such hearings.
- Ensure that the Race Committee, Officials, Drivers, Riding Crew and Boat Owners obey and comply with all provisions of the Rules.
- Report any breach of the Rules to the Officer of the Day, recommending any improvements that can be of benefit to the event.

**105.48 A REFEREE IS AUTHORISED AND IS EXPECTED TO:**

- Ensure compliance with the Rules at all times.
- Advise the Race Committee before deciding questionable points relative to incidents on the racecourse, proper handling of the event or interpretation of the Rules.
- Instruct Officials if they are obviously unfamiliar with their duties.

- Overrule the Race Committee in the event of any improper decision on the day of the event only.
- Decide if the weather conditions are suitable to start the Event or a Race. The decision of the Senior Referee is final.
- Decline to allow a claim for a Record or Championship if judged that the Rules have not been enforced or complied with during the event.

## **105.50 INSTRUCTIONS TO REFEREES**

- 105.51 The Senior Referee, Assistant Referee and Course Referees are appointed by the respective Council in control of the Event.
- 105.52 The Senior Referee may utilise the services of the Assistant Referee to carry out the course inspection and accompany Scrutineers during Scrutineering and to assist in supervising the Event.
- 105.53 At Championship Events, the Course Referees will accompany any appropriate course Officials. The Course Referee will be stationed at positions they consider appropriate to view Drivers negotiating the turning buoys at each end of the course during the conduct of a Race. Course Referees are empowered to specify or advise appropriate positions.
- 105.54 Course Referees must ensure that all Rules are complied with and they submit their respective reports at the conclusion of each Race direct to the Race Committee.
- 105.55 At Speed & Time Trials, the Course Referees are stationed at each timing point to supervise the work of the timekeepers and recorders.
- 105.56 At Cruiser Championships, the services of the Course Referees are to be utilised when and where necessary at the discretion of the Senior Referee.
- 105.57 At all events, the Senior Referee must ensure that all provisions of the Rules are complied with and to report to the respective Council any shortcomings.

## **105.60 REFEREE REPORTS**

- 105.61 After the conclusion of the Event, the Senior Referee must complete the Referee's Report and forward the report to the respective Council Secretary within fourteen (14) days of the Event.
- 105.62 The Senior Referee must note on the Referee's Report the serial number of any sealed engine before or after the event, and the seal number used.
- 105.63 For Speed & Time Trials, the Senior Referee must sight the Timing Device Certificate and check that the Certificate is for the timing devices used. The Referee must note the certificate number and date of the certificate in the Referee's Report.

## **105.70 ELIGIBILITY AND APPOINTMENT AS AN HONORARY AUSTRALIAN REFEREE**

- 105.71 The title of Honorary Australian Referee is given to persons who have given distinguished service to The Association as an Australian Referee.
- 105.72 To be eligible for appointment as an Honorary Australian Referee, such persons must have given service as an Australian Referee for a minimum period of fifteen (15) years consecutively.
- 105.73 The appointment of an Honorary Australian Referee is at the discretion of the respective Council or The Association.
- 105.74 An Honorary Australian Referee is entitled to receive a copy of the Rule Book annually at no charge, which is to be provided by The Association.

## **106 TROPHIES**

- 106.01 The Association may reallocate a Championship trophy to another Class where less than the required number of entries to constitute a Class are received in any particular Class for two (2) years in succession in either Inboard or Outboard Championship Events.
- 106.02 The EC Griffith Cup Trophy is vested in The Association in accordance with the Deed of Gift.
- 106.03 All Australasian, Australian and State Championship trophies (and carrying case) must be returned by the previous holder to the Club or Council conducting such Championship(s) at least one (1) hour before the start of the Event where such Championship is to be contested.
- 106.031 The Association may request in writing to the holder of an Australasian or Australian trophy that the trophy is to be made available, no more than two months before the advertised date of the running of the next Event, for promotional purposes.
- 106.04 Failure to return the trophy is subject to a fine of one (1) unit and where the holder was to contest that or another Championship at the Event, is ineligible to participate in such Championships.
- 106.05 It is the responsibility of each Council to ensure that all Championship trophies held in the respective state are returned in good condition to the Council or Club conducting the Event before the stipulated deadline.
- 106.06 Any trophy allocated to a Championship not contested must be returned to The Association by the Council of the holder of the trophy.
- 106.07 Failure by the respective Council to ensure that the trophies are returned will be subject to a fine of

one (1) unit in addition to any penalty imposed on the holder.

- 106.08 The Arch Spooner Gold Cup, the Kerry Rogers Memorial Trophy and the Len Sheltrum Marine Trophy are not required to be transported to the Championship venue each year due to the fragility of the trophies. Arrangements must be made between the current holder and the new holder for the transportation and safekeeping of the trophy as necessary.
- 106.081 The Secretary must be notified in writing of any change to the holder or the custodian of the above-named trophies by the current holder.
- 106.09 The possession of any State Perpetual Trophy is at the discretion of the respective Council.
- 106.10 Any Council, Club or person taking possession of a trophy will be deemed to have received such trophy in good condition unless a report is submitted to The Secretary within 14 days of receipt of the trophy stating otherwise.
- 106.11 Australian Championship trophies must remain in Australia.
- 106.12 The winner of an Australasian Championship trophy is to provide a bond as set out in Rule 106.122 and a copy of an appropriate insurance policy, to The Secretary before the winner is permitted to take possession of the trophy.
- 106.121 The bond will be returnable, less any repairs that may be deemed as necessary.
- 106.122 The bond amounts are:
- \$1,000 for the E C Griffith Cup
  - \$250 for A E Baker Trophy and Marjorie Watson Trophy
- 106.13 When the winner of an Australasian Championship trophy cannot meet the requirements of Rule 106.12, custody of the trophy will revert to The Association and the trophy will be kept at the discretion of The Association until the next running of that Championship.
- 106.14 Such trophies can only be released to an authorised representative of The Association.

## **107 CONDUCT OF MEMBERS**

- 107.01 The Association will not tolerate any verbal or physical abuse of its Members or Officials.
- 107.02 Any Driver, Riding Crew, Boat Owner or other class of Member of The Association that is found to have verbally or physically abused another Driver, Riding Crew, Boat Owner, Official, APBA Official or member of the public at an Event or meeting of The Association or Council will be disqualified immediately from that Event or meeting and will be asked to leave the venue.
- 107.03 A Driver and/or Boat Owner will be deemed to be responsible for the conduct and behaviour of their Crew Members. In the event that a Crew Member is found to have verbally or physically abused a Driver, Riding Crew, Boat Owner, Official, APBA Official or member of the public at an Event and such Crew Member is not a member of The Association, the Driver and/or Boat Owner will be handed the penalty.
- 107.04 Such behaviour will result in the offender automatically receiving a Red Card and any further penalty associated with a Red Card.
- 107.05 Any Driver, Riding Crew, Boat Owner, or other class of member of the Association deemed to have committed any of the following:
- Acted in an unsportsmanlike manner;
  - Acted in a manner likely to bring the sport into to disrepute;
  - Committed a serious moral or sporting offence; or
  - Acted in a manner unbecoming of a member and prejudicial to the interests of The Association;
- will be subject to the penalties as listed in “Rule 103 – Penalties” and/or the “Rules of the Association – Subsection 6 – Termination of Membership.”

## GROUP 200 – ENTRIES

- 201 GENERAL CONDITIONS**
- 202 OWNERSHIP**
- 203 LODGEMENT OF ENTRY**
- 204 RACE NUMBERS**
- 205 CREWS**

### **201 GENERAL CONDITIONS**

- 201.01 An Entry will only be accepted on condition that the Driver, Riding Crew, Boat Owner, or any person or persons connected with the Boat entered, will not hold any other Driver, Riding Crew, Boat Owner or person or persons connected with any other Boat entered liable for any personal injury or damage resulting from any accident that may occur whilst participating in any Event.
- 201.02 The Boat Owner of a Boat entered must be the holder of a Boat Owner Licence. The Boat Owner of the Boat entered must own and be in the possession of and produce for inspection when called upon to do so, the following:
- A current Rule Book and/or Licence Book;
  - A current Log Book for that Boat;
  - All other documents as required by the Rule Book.
- 201.021 Boat Owners must be familiar with the Rule Book and any special rules applicable before participating in any Event.
- 201.03 The Driver and Riding Crew of a Boat must be the holder of a Driver Licence. The Driver and Riding Crew of the Boat must own and be in possession of and produce for inspection when called upon to do so the following:
- A current Rule Book and/or Licence Book;
  - All other documents as required by the Rule Book.
- 201.031 Drivers and Riding crew must be familiar with the Rule Book and any special rules applicable before participating in the event.
- 201.032 The onus is on the Driver and Riding Crew to ensure they have completed a breath test, passed Scrutineering and completed an Indemnity Form.
- 201.033 Failure to complete any or all of these requirements can result in a one (1) unit Fine and the issue of a Yellow Card.
- 201.04 Drivers, Riding Crew and Boat Owners must comply with all SBA regulations applicable to racing boats in the state in which the Boat is registered.
- 201.05 All Drivers and Riding Crew must comply with minimum age requirements set by the Rules Book and by the relevant SBA.
- 201.06 The rules and regulations governing any Event apply to all Drivers, Riding Crew, Boat Owners and Crew Members of Boats and all participants accept such rules and regulations from one (1) hour before the start of the Event until the official conclusion.
- 201.07 For Championship races conducted in heats, there must be no change of hulls during or between heats.
- 201.08 Drivers, Riding Crew and Boat Owners who are a member of an interstate Club are eligible to compete in any State Championship but the venue of such Championship must not move from the State of origin.
- 201.09 BREATH TESTING**
- 201.090 No Driver or Riding Crew will be permitted to compete in any Event whilst under the influence of intoxicants or prohibited substances.
- 201.091 All Drivers and Riding Crew must submit to a breath test analysis at or in conjunction with the Briefing or at any designated time specified on the programme.
- 201.092 A Club or Council conducting an Event may carry out a random breath test on any Driver or Riding Crew throughout the duration of an Event. Competitors must be notified of the intention to carry out random breath tests at the Briefing.
- 201.093 Refusal to submit to a breath test in conjunction with either the Briefing or when requested randomly by an Official will result in automatic disqualification of the Driver and/or Riding Crew from the Event.
- 201.094 All Drivers and Riding Crew must record a blood/alcohol content of zero (0.00%).



- 201.095 Where the breath analysis equipment shows any alcohol at all is present, the Driver or Riding Crew cannot compete on that day of the Event.
- 201.096 In the event that the breath analysis equipment is considered faulty, Officials may afford a Driver a second test or use of other breath analysis equipment (if available). Such test is to be conducted within ten (10) minutes of the original test, or at the recommended minimum interval, as given by the manufacturer of the equipment being used.
- 201.097 The consumption of alcoholic beverages within any Pit Area is prohibited.
- 201.098 Any Driver, Boat Owner, Riding Crew or Crew Member consuming alcoholic beverages within any Pit Area will be immediately removed and prohibited from taking any further part in that Event.
- 201.099 The decision of either the Referee or Race Committee on breath testing is final and cannot be appealed.
- 201.100 FAILING A BREATH ANALYSIS TEST - The following penalties will apply to any Driver or Riding Crew who returns a positive reading following a breath test conducted under Rule 201.09 at any sanctioned event.
- 201.101 Penalties for second and third offences apply to positive readings returned within a 12-month period of the first positive reading.
- 1st Offence: 2 Yellow Cards and the Driver will not be permitted to race on that day of the Event. The boat will not be disqualified from that Event.
- 2nd Offence: 1 Yellow Card, which will automatically become a Red Card (see Rule 104.035). This will entail an automatic three-month suspension from competing.
- 3rd Offence: A minimum suspension of 12 months from competing as determined by the Drivers' Council.
- 201.102 The Club will then provide written advice to their respective Council of any Driver that has infringed this rule within fourteen (14) days of the occurrence.
- 201.103 The Council will then provide written advice to The Association and The Association's Safety Officer within twenty-eight (28) days of the occurrence.
- 201.20 DRUG TESTING – Random drug testing will be conducted in accordance with The Association's Illicit Drugs Policy. Any Driver, Boat Owner or Riding Crew found to be in possession of or testing positive to the use of illicit or illegal drugs or substances will incur the following penalties:
- 1st Offence: A minimum 12-month prolonged suspension. In the case of a positive test offender, a negative test must be provided once the suspension has expired. The cost of the clearance test is to be paid for by the offender.
- 2nd Offence: Lifetime ban from the sport.
- 201.30 NOISE LIMITS – All competing boats must comply with any noise limit imposed by The Association, a Council, Club or any Federal, State or Local Authority. Any such noise limit must be advised in advance of any Event.

## **202 OWNERSHIP**

- 202.01 Every Boat entered in an Event must be on the register of a Club in the name of the Boat Owner before the closing date of entries.
- 202.02 The Boat must be the bona-fide property of the Boat Owner, or under charter to the Boat Owner.
- 202.03 A person who has chartered a Boat is considered to be the Boat Owner.
- 202.04 No Boat under charter will be entered or permitted to enter an Event unless chartered for at least ninety (90) days before the Event.
- 202.05 If ownership certificates are required, these will be provided on request and without a fee to members of affiliated Clubs.
- 202.06 In the case of a Boat Owner owing money to The Association, any Boat/s under the same or part same ownership will not be permitted participation in an Event.
- 202.07 No restrictions apply to the name of a Boat other than the use of names that are obscene or might be of such a nature as to cause embarrassment and cast discredit on the sport.

## **203 LODGEMENT of ENTRY**

- 203.01 For Championships and Speed & Time Trials, every entrant must lodge an Entry Form in the form prescribed by The Association and must sign the standard declarations and give the data requested.
- 203.02 Any Driver or Boat Owner wishing to enter a Championship (other than Offshore Championship), Speed or Time Trial, Special Record Attempt or Special Event must complete an Entry Form. The Entry Form must be accompanied by a current Engine Measurement Certificate confirming that the engine has been measured, sealed and is eligible for the Class entered. Exemption to the provision of the Engine Measurement Certificate may be granted by the host Council.

- 203.021 The Entry Form, together with any prescribed fee (refer to Rule 203.072) is to be forwarded in the first instance to the Secretary of the Council (not Club) conducting the event, thirteen (13) days before the Event or seven (7) days before the Event in the case of Drag Boat Championships.
- 203.022 Electronic lodgement (fax, email, etc) of an Entry Form to any Event will be permitted.
- 203.023 The original of the Entry Form, together with any necessary fee, is to be in the hands of the Race Committee of the Club conducting the Event at least one (1) hour before the scheduled start of the Event.
- 203.03 Late Entries will be accepted for Australasian and Australian Championships provided the Late Entry is in the hands of the Race Committee at least one (1) hour before the scheduled start time of the Event and the requirements of Rule 203.05 and 203.051 have been met.
- 203.031 Late Entries for State Championships are at the discretion of the respective Council. Such Late Entries are permitted one (1) hour before the scheduled starting time of the Event and will not be received unless at least four (4) bona fide entries had already been received thirteen (13) days before the Event.
- 203.032 Late Entries for Speed & Time Trials are permitted if lodged with the Race Committee conducting the Event at least one hour before the scheduled start of the Event.  
The Entry must be on an Entry Form (refer to Rule 203.01) and will be received subject to there being sufficient time to permit such runs to be made.
- 203.033 Late Entries are subject to a fee (refer to Rule 203.073)
- 203.034 Late Entries where permitted are to be on the outside of the field.
- 203.04 Any Driver or Boat Owner giving false information can be disqualified from the Event and can be barred from entering any Event for a defined period.
- 203.05 For Australasian and Australian Championships, there must be four (4) bona fide entries received thirteen (13) days before the date of the event to constitute a Championship for Inboard and Outboard Classes.
- 203.051 For Drag Racing Classes, two (2) entries received in accordance with the requirements of the Rules constitute a Championship Class.
- 203.052 If entries are not received as per rule 203.05 then that championship class shall be eligible to be reallocated with the consent of the original allocated host council not less than 30 days after the original allocated date.
- 203.06 For Australasian and Australian Championships, the Secretary of the Council conducting the Event must notify nominated entrants immediately after the close of entries if there are insufficient entries to constitute a Championship Event.
- 203.07 ENTRY BOND** – A bond of \$150 per **Event** entered must be lodged with each entry to all Australasian and Australian Championships, Speed or Time Trial events. The bond will be returned to the entrant once their Boat has been presented for Scrutineering at the Event, or if the Event is cancelled, or at other times at the discretion of the Club or Council conducting the Event.
- 203.071 The Club conducting the Event is responsible for the collection of any applicable Ambulance or Safety Levies. Such levy must be on a pro-rata basis, e.g.: Ambulance costs divided by the total entries give the levy per entry.

**203.072 ENTRY FEES/BONDS**

<b>Australasian and Australian Championships</b>	<b>\$150</b>
<b>State Championships</b>	<b>Discretion of the Council</b>
<b>Speed and Time Trials</b>	<b>\$150</b>
<b>World and Special Record Attempts</b>	<b>\$100</b>
<b>Special Events</b>	<b>Fee set by Race Committee and subject to Council approval.</b>

**203.073 POST ENTRY FEES** when permitted by the Rules are the property of the Council.

<b>POST ENTRIES (for State Events and Trials)</b>	<b>\$50</b>
<b>POST ENTRIES (for Australasian/Australian Events)</b>	<b>\$150</b>

**203.08 LODGEMENT OF ENTRY - Club Day**

203.081 For Club Days and all events other than Championships and Speed & Time Trials, every entrant must lodge an Entry Form in the form prescribed by The Association and must sign the standard declarations and give the data requested.

- 203.082 Any Driver or Boat Owner wishing to enter a Club Day and all events other than Championship, Speed or Time Trial, Special Record Attempt or Special Event must complete an Entry Form. If required the Entry Form must be accompanied by a current Engine Measurement Certificate confirming that the engine has been measured, sealed and is eligible for the Class entered.
- 203.083 The Entry Form, together with any prescribed fee is to be forwarded in the first instance to the club conducting the event at a date indicated by that club.
- 203.084 Electronic lodgement (fax, email, etc) of an Entry Form to any Event will be permitted.
- 203.085 The original of the Entry Form, together with any necessary fee, is to be in the hands of the Race Committee of the Club conducting the Event at least one (1) hour before the scheduled start of the Event.
- 203.086 The Club conducting the event shall maintain their records and entry forms for a period as stipulated by their state government regulations.

## **204 RACE NUMBERS**

- 204.01 **Every boat must have a Race Number clearly visible vertically on each side of the boat. Boats competing at Drag Section events are exempt from the requirements of this rule.**
- 204.011 Race Numbers must be of a colour that clearly contrasts from the background.
- 204.02 Official Race Numbers, preceded by any appropriate State and Class Symbol are to be issued by each Council, and are the property of the Boat owner while the Boat Owner is a financial member of a Club.
- 204.021 A Council may charge a fee for issuing a Race Number.
- 204.03 No Boat Owner may apply a race Number to a Boat unless the Race Number has been allocated in accordance with Rule 204.02.
- 204.04 No Boat will be permitted to start in an Event unless a Race Number is clearly displayed. Boats competing at Drag Section events are exempt from the requirement of this Rule.
- 204.041 The absence of a Race Number or part of a Race Number which makes the Race Number illegible, will lead to Disqualification. Boats competing at Drag Section events are exempt from the requirement of this Rule.
- 204.05 No boat will be permitted to start in an Event unless its SBA Registration number and current Registration Label are displayed as required by the SBA Regulations.
- 204.06 The Race Committee is responsible for the enforcement of Rules 204.01, 204.011, 204.012, 204.04, 204.041 and 204.05.

## **205 CREWS**

- 205.01 The Driver of the Boat is wholly responsible for the safety of the Riding Crew and Crew Members.
- 205.02 Should any Riding Crew fall overboard from a Boat during a Race; the Driver must stop the Boat immediately and retrieve the lost Riding Crew.
- 205.03 In ocean racing, a Riding Crew of at least three (3) must be carried on Cruisers of all classes, as defined in the Group 1500 Rules, of who two (2) must be capable of handling the Boat and hold a SBA Licence if required by the speed of the boat and the SBA Regulations.
- 205.04 Appropriate enclosed footwear must be worn by all Drivers, Boat Owners, Riding Crew and Crew Members at all times when in the Pit Area.

## **GROUP 300 – MANAGEMENT OF EVENTS**

- 301 SUSPENSION OF RULES**
- 302 GENERAL CONDITIONS**
- 303 POSTPONEMENTS**
- 304 INSPECTIONS AND BRIEFINGS**
- 305 MANAGEMENT OF EVENTS ADDITIONAL**

### **301 SUSPENSION of RULES**

- 301.01 When on account of local conditions, special Racing Rules, exemptions or amendments to the Rules are deemed necessary by the Race Committee for a particular Event, then the Race Committee must forward in writing to The Association, through its respective Council, at least ten (10) weeks before the date of the Event, suggested exemptions or amendments for approval by The Association.
- 301.02 If approved by The Association, these changes may then be used throughout that Event.
- 301.03 During any Event no Rules of a safety nature may be abridged by any Special Rule or Condition or by any Deed of Gift.

### **302 GENERAL CONDITIONS**

- 302.01 All Championships, Speed & Time Trials and Special Record Attempts must be conducted by The Association, a Council or a Club using an experienced team of Officials.
- 302.02 No Driver, Riding Crew, Boat Owner or Official may take part in any event which is not sanctioned by The Association and conducted or controlled by The Association, a Council or Club.
- 302.021 Any Driver, Riding Crew, Boat Owner or Official found to have breached Rule 302.02 may be Suspended for a period to be determined and Excluded if the offence recurs.
- 302.03 A Race Committee will organise and control an Event in conjunction with any Officials appointed by The Association or Council.
- 302.031 Councils are responsible for the appointment of the Referees to be present at each Event.
- 302.032 Referees for regional Championships and Club Events are at the discretion of the Council.
- 302.04 There must be at least one (1) Australian Referee present at every Australasian and Australian Championship, Speed & Time Trial, and Special Record Attempt as the Senior Referee.
- 302.05 Drag Events under the control of a nominated Race Director and Events, other than Speed & Time Trials or Special Record Attempts conducted under the control of the Offshore Council or Australasian Speed Record Attempts conducted by the New Zealand Power Boat Association Inc., are excluded from the requirement of Rule 302.04.
- 302.06 Any decision of the Race Committee must be based on the Rule Book. However, as no rules can be devised capable of meeting every incident or accident of racing, the Race Committee must be guided by the ordinary customs of the sea and must discourage all attempts to win a Race by other than fair racing, superior skill, and speed.
- 302.061 Clubs may use their own Club rules as an addendum and in conjunction with the Rule Book.
- 302.07 No Official, no member of a Race Committee, or authorised representative of either one or the other may take part in any decision of any question in which they may be directly interested. Nor may any Engine Measurer, Scrutineer, or Scrutineer become involved with any Boat or motor against which they will be competing against in any Event.
- 302.08 Australasian and Australian Championships, Speed & Time Trials or Special Record Attempts that are not organised in conformity with the Rule Book can be declared a "NO EVENT".
- 302.081 The Council and/or Club disobeying or failing to carry out the requirements of the Rule Book, must be penalised, and can be prohibited from conducting an Event for such period as determined by The Association.
- 302.09 The failure of the Race Committee or any Official directly or indirectly connected with the management or conduct of an Event to comply with the Rule Book will not affect the responsibility of any competitor or competitors' duty to obey all Rules.
- 302.10 Only Officials actually conducting the Event are permitted on the premises set aside for their use during the Races of any Event.
- 302.11 No Driver or Boat Owner or person representing the Driver or Boat Owner of a Boat is permitted on the premises used as the operating headquarters by the Race Committee during the running of a Race.

- 302.111 If requested to come to headquarters, the Driver, Boat Owner or representative may do so but must depart immediately after the matter that prompted the request to attend has been dealt with.
- 302.112 Failure to leave the headquarters when requested will disqualify the Boat owned and/or operated by the party so refusing.
- 302.12 For Championships, Clubs conducting Events must have the Event suitably advertised in the media and in any other way they deem fit to attract the public interest.
- 302.121 The Club must provide reasonable facilities for the media during the Event and must see that the results and description of the Event are fairly and correctly recorded in the media.
- 302.13 Perpetual Trophies for Championships, where practical, must be displayed at the venue at which the Event is being conducted.
- 302.131 Perpetual Trophies for Championships conducted as a Series are only required to be displayed at the final Event of the series.
- 302.14 Championship, Speed & Time Trial, or Special Record Attempt courses must be laid down at least one (1) hour before the official starting time of the Event for inspection by the Referee.
- 302.15 The Rules applicable to the Event are also applicable to any practice sessions allocated before the Event by the Council or Club conducting the event.
- 302.151 It is strongly recommended that competitors do not test or practice Boats in non-Event conditions. In the event of such activities being carried out competitors must:
- Comply with all applicable Civil Regulations applying to location and time (including but not limited to noise and civil safety equipment requirements).
  - Conduct themselves in a manner not likely to bring the sport into disrepute.
- 302.152 It is strongly recommended that where appropriate, Clubs provide test or tuning days in conjunction with Events - either the day prior or same day.
- 302.16 The starting time for a Championship Event must not be later than 3.30pm and in every instance, the starting time must appear on the programme.
- 302.17 When a Rule does not seem clear on any point, the official interpretation will be that of the majority of the Race Committee given in writing and duly recorded.
- 302.171 Where an Australasian or Australian Championship, or Record is involved, the decision of the Race Committee will be subject to review and approval of The Association before being ratified.
- 302.172 Where a State Championship or Record is involved, the decision of the Race Committee will be subject to review and approval of the Council before being ratified.
- 302.18 Councils or Clubs conducting events should ensure that a copy of the Deed of Gift or any Special Rules governing the Event are available for reference.
- 302.19 Boats must race without handicap or time allowance in all Championships except in the Formula Future Class or specific Handicap Championships.
- 302.191 Handicap Races may be conducted in conjunction with Championship Events provided they do not infringe Championship conditions and only with the approval of the Council.
- 302.20 Except when conducted as a Series, where the holder of a Championship is the only starter, the Trophy and Championship may again be assumed without running the course, but where the only starter is not the holder; the boat must complete one (1) lap of the course to become the holder.
- 302.21 During the conduct of an Event, the Officer of the Day is the Senior Official of the Race Committee in the Tower.
- 302.22 A Race Secretary must act as liaison between the Race Committee and the Referee.

### **303 POSTPONEMENTS**

- 303.01 The Referee may postpone an Event of Race should unfavourable weather conditions or extraordinary circumstances make a postponement advisable.
- 303.011 Sufficient notice of change of time of start must be given to all contestants.
- 303.02 An Event or Race postponed and not conducted within a period of fourteen (14) days is considered a new Event or Race.
- 303.03 Championship Events or Races not conducted due to weather or extraordinary circumstances and which cannot be held within 14 days, may, with the approval of The Association or Council, be rescheduled to a date no closer than 1 month from the original date.
- 303.031 Existing entries will stand. However, new entries can be lodged.
- 303.032 Notification must be made in writing to all existing entries and Councils notified within the period given in Rule 101.04

### **304 INSPECTIONS and BRIEFINGS**

- 304.01 Boats must be presented for Scrutineering by an Official Scrutineer, as appointed by the Race Committee, to ensure compliance with the Rule Book. The Scrutineer may be accompanied by a

- Referee.
- 304.011 Boats must be inspected to ensure that the boat is seaworthy, of safe construction, and that all mechanical devices for steering, throttle, etc., and such other gear is carried as defined in the specific Section Rules for each Class and is in good order.
- 304.012 Personal Floatation Devices (PFD) and helmets must be inspected to ensure sound condition and colour in accordance with the Rules.
- 304.013 All Scrutineering must be recorded in writing and be lodged with the Race Committee, and any reports on violation of the Rules must be submitted to the Race Committee immediately for action. Such violations must also be recorded in the Driver or Boat Owner's Rule Book and/or Log Book.
- 304.014 All Boats must, prior to each Boat's first Event of each Licence Year, undergo an Annual Technical Inspection to ensure compliance with the Rules. The Technical Inspection will be carried out by a Technical Inspection Scrutineer authorised by each Council. Upon successful completion of the Technical Inspection a sticker issued by The Association and valid for that Licence Year will be affixed to the Boat, within 300mm of the steering wheel, by the Technical Inspection Scrutineer.
- 304.015 Any Boat involved in an incident, as defined by The Association, must undergo a further Technical Inspection prior to resumption of racing.
- 304.016 Any Boat may be subjected to a further Technical Inspection within any Licence Year if, in the opinion of an Official, the Boat has been subjected to modification or material change.
- 304.02 If in the judgement of the Officer of the Day, a Boat is unseaworthy, unsafe, unmanageable, or has failed to live up to the spirit or letter of the Rules immediately before the start or during the Event, the Race Committee may refuse to allow the Boat to start or continue to compete in an Event.
- 304.03 If in the judgement of the Officer of the Day, any published Rules have not been complied with by a Driver or Boat Owner before the start of any Event, the Race Committee may decline to permit the Boat to start except for the provision in Rule 304.04.
- 304.04 The Race Committee does not have the power to disqualify a Boat for breach of any Rule unless the Driver or Boat Owner has been informed of the intention to disqualify and the Driver and/or Boat Owner has failed to rectify the fault and comply with the Rules after having been informed.
- 304.05 Drivers' apparel as required under Rule 801, and the Boat must be presented for Scrutineering and for checking of information furnished on the Entry Form, at least one (1) hour before the scheduled start of the Event or the day before the Event if so advised by the Race Committee.
- 304.06 Drivers and Boats must be in attendance by the time advertised and notified to all entrants prior to the Event or if no such notification has been given, one (1) hour before the advertised start of the Event.
- 304.061 Entrants at the Combined Inboard, Combined Outboard, or Combined Inboard and Outboard Championships need only to attend the venue for Scrutineering and Briefing on the day of the Races in which they are entered.
- 304.07 Drivers and Riding Crew must be present at the Briefing.
- 304.08 Failure to comply with any or any part of Rules 304.05, 304.06, and 304.07 will result in disqualification from the Event except in extenuating circumstances approved by the Race Committee.
- 304.081 Such circumstances are to be communicated to the Race Committee, preferably by telephone, at least one (1) hour before the start time nominated in the programme.
- 304.082 Any decision on action to be taken is entirely at the discretion of the Referee.
- 304.09 The Driver and Riding Crew of any boat fitted with a Reinforced Cockpit, a deflection bar or lap belt must ensure that before the Boat enters the water at any Event, or official practice session, such equipment is inspected by any rescue divers for familiarisation with the cockpit, release systems, and other pertinent matters.
- 304.10 A Duty of Care Statement, as approved by The Association, must be read out at every Briefing at an Event.
- 304.11 Every Briefing must be recorded electronically, and the recording kept for as long as required by law, especially in relation to accidents, injuries or deaths.
- 304.12 Start boat must be presented for Scrutineering by an Official Scrutineer, as appointed by the Race Committee, to ensure compliance with the Rule Book. The Scrutineer may be accompanied by a Referee.**
- Start boat must be inspected to ensure that the boat is seaworthy, of safe construction, and that all mechanical devices for steering, throttle, etc., and such other gear is carried as defined by the general**
- 304.121 **All start boat Scrutineering must be recorded in writing on the Start Boat Scrutineering Form and be lodged with the Race Committee, and any reports on violation of the Rules must be submitted to the Race Committee immediately for action.**
- 304.122 **Start boat driver and crews Personal Floatation Devices (PFD) and helmets must be inspected to ensure sound condition and colour in accordance with the Rules.**

- 304.123      **The host club accept all responsibility for the compliance of the start boat and crew along with their actions.**
- 304.124      **The driver of the start boat as well as the Starter must be present at the briefing.**

## **305      MANAGEMENT OF EVENTS ADDITIONAL**

- 305.1      Overseas Competitors  
An overseas vessel which complies with its own National Authority Rules, may be granted approval to compete in any special events conducted in Australia by application to the relevant State Council who shall submit request to the National Authority to be approved. Each application to be reviewed on its own merit. Application should be submitted at least 30 days prior to the event.
- 305.2      Demonstrations  
Boats that do not comply with current APBA Rules may be granted an exemption to run at sanctioned events by application to the relevant State Council who shall submit request to the National Authority to be approved. Each application to be reviewed on its own merit. Application should be submitted at least 30 days prior to the event.

## GROUP 400 – PROTESTS AND APPEALS

### 401 GENERAL

### 402 PROTESTS

### 403 APPEALS (First)

### 404 APPEALS (Further)

### 405 ADMINISTRATIVE APPEALS

#### 401 GENERAL

- 401.01 All Protests regarding the eligibility of Boats, Drivers, Racecourse or of the Officials must be made to the Race Committee as soon as the violation of the Rules is discovered.
- 401.011 Starting in a Race will be taken as an acceptance of all conditions without protest, unless a Protest is lodged before the start of the Race or Event.
- 402.012 The Race Committee may reject all Protests filed after a Race if prior knowledge of the alleged breach(s) is/are admitted or proven during the investigation, and no further action will be taken.
- 401.02 No trophies or prize moneys are to be awarded or presented while a Protest or Appeal is pending.
- 401.03 A Protest or Appeal can only be lodged by a Boat Owner or Driver actually competing or who has competed at the Event.
- 401.04 Protest and/or Appeal fees will be returned if the Protest or Appeal is upheld. Bond moneys will be returned, less any expenses.

#### 402 PROTESTS

- 402.00 Protests can only be heard by the Race Committee responsible for the conduct of the Event.
- 402.01 Protests regarding eligibility of Boat, Drivers or relating to the conduct of any Event, alleged breach of the Rules or any penalty imposed must be lodged with the Race Committee and be made on the appropriate form accompanied by a Protest Fee of Two Hundred Dollars (\$200).
- 402.011 Protests must be lodged: -
- Before the Race as required under rule 401.01 or
  - Within thirty (30) minutes of the conclusion of the Race concerned, or
  - Within thirty (30) minutes of issue of notification of the breach or penalty.
- 402.012 The Race Committee must notify any competitor who is the subject of a Protest or affected by the Protest, immediately after receipt of the Protest.
- 402.02 If the Protest is against a sealed motor, a bond of Five Hundred Dollars (\$500) must accompany the Protest to cover the cost of dismantling the motor.
- 402.021 If the Protest is upheld the bond will be returned. Motors that are dismantled due to a Protest are to be assembled at the expense of the loser of the Protest.
- 402.03 Protests must be heard without delay and the Protest decision conveyed to the Protestor, any competitor who was the subject of a Protest, or affected by the Protest, and the Council in writing, by the Race Committee immediately after the hearing.
- 402.04 Protests regarding the eligibility of Boats or Drivers should be heard before the Race or Event commences.
- 402.041 Starting in any Race or Event will be taken as acceptance by the competitor of the conditions without Protest, unless a Protest has been lodged before the start of the Race or Event.
- 402.05 The Senior Referee must attend any Protest Hearing.

#### 403 FIRST APPEAL

- 403.01 After any Protest has been decided by the Race Committee, the first Appeal against the decision of the Race Committee must be made by the Appellant in writing, accompanied by a fee **as set annually by the National Council** and lodged with the relevant Council Secretary, within seven (7) days of the Protest decision.
- 403.011 For Events conducted as a single Event, the relevant Council is the Council in which the Event was conducted.
- 403.012 For Events conducted as a Series, the relevant Council is the Council overseeing the Series.



- 403.013 For Offshore Events, the relevant Council is the Offshore Council.
- 403.014 All particulars (including relevant supporting Rule Numbers), the names of any interested parties or witnesses and their role in supporting the Appeal must be included.
- 403.015 The Appeal will be heard by the respective Council and the hearing must be held within twenty-eight (28) days of the Protest decision.
- 403.016 Any competitor who may be affected by the Appeal must be notified by the relevant Council immediately after the Appeal has been received.
- 403.017 The Appeal decision must be conveyed to the Appellant, any affected competitor and The Association, in writing, within seven (7) days of the Appeal hearing by the Council.

#### **404 FURTHER APPEAL**

- 404.01 If after the decision of the Council, a party to the First Appeal wishes to lodge a Further Appeal, they may do so through their Council to The Association.
- 404.011 The Further Appeal will be heard by the National Appeals Committee who may hear the Further Appeal by personal appearance of all parties, or by Statutory Declarations by such parties.
- 404.012 The Further Appeal must be lodged within seven (7) days of the date of the lodgement of the notification of the decision of the First Appeal and must be accompanied by a fee **as set annually by the National Council**.
- 404.013 If the decision is to hear the Further Appeal by personal appearance of the parties, a bond of One Thousand Dollars (\$1,000) to cover expenses to hear the Further Appeal must be lodged by the Appellant through their Council before the setting of the date to hear the Further Appeal.
- 404.14 The National Appeal Committee will notify all parties of the dates when the Appeal will be held. All paperwork must be in the hands of the Appeal Sub Committee by that date. No late correspondence will be accepted.
- 404.02 The decision of the National Appeals Committee relating to a Further Appeal is final and no further Appeal will be accepted.

#### **405 ADMINISTRATIVE APPEAL**

- 405.01 An Administrative Appeal can be made by a competitor against any decision of a **Club**, Council or The Association in relation to a race incident or matter deemed to be of an administrative nature.
- 405.011 An Administrative Appeal can be made by a competitor affected by any such decision of a **Club**, Council or The Association.
- 405.012 An Administrative Appeal cannot be made against any decision made as a result of a Protest lodged at an Event.
- 405.013 The Administrative Appeal must be lodged with The Association within seven (7) days of the notification of the decision of the meeting at which the decision being appealed was made and must be lodged through the respective Council.
- 405.014 Such Appeal must be in writing and accompanied by a fee **as set annually by the National Council**
- 405.015 A bond **as set annually by the National Council** in addition to the appeal fee must accompany the Administrative Appeal.
- 405.016 The Appellant must include three (3) copies (the original and two copies) of all relevant particulars relating to the Appeal (particulars mean: the appeal, supporting statements, letters, instructions, etc.).
- 405.017 The Administrative Appeal will be heard by the National Appeals Committee either by Statutory Declaration or by personal appearance by the respective parties.
- 405.018 If the appeal is heard by personal appearance, an additional bond of One Thousand Dollars (\$1000) will be required to cover expenses can be requested before the appeal hearing proceeds.
- 405.019 In regard to issuing Yellow and Red cards a technical error shall not invalidate a report. In particular a report shall not be ruled invalid by reason only of an error or omission in stating date, time or place of the report, the capacity in which the person making the report was officiating or the rule number under which the report was made.
- 405.02 The decision of the National Appeals Committee relating to an Administrative Appeal is final and no further Appeal will be accepted.

# GROUP 500 – RECORDS

- 501 ELIGIBLE CLASSES**
- 502 COURSES**
- 503 TIMING**
- 504 METHODS OF TIMING**
- 505 CALCULATIONS**
- 506 MARGINS**
- 507 INTERVALS AND INTERRUPTIONS**
- 508 ELIGIBILITY TO CLAIM**
- 509 SPECIAL RECORD ATTEMPTS**
- 510 WORLD RECORD ATTEMPTS**
- 511 INTERCITY RECORD ON OCEAN COURSES**
- 512 SPEED ACHIEVEMENT AWARDS**

## **501 ELIGIBLE CLASSES**

- 501.01 Inboard, Outboard and Offshore Classes are eligible to compete for and receive official Australasian and Australian Record Certificates for the Classes as listed in addition to any granted by individual Councils.
- 501.011 Australian Record Certificates only are issued for the Quarter Mile course and the TIME only is to be shown on the Certificate.
- 501.012 When a Class is modified to improve or reduce the performance of the Class, the established records before the Class modifications will be frozen and a new series of records will be started.  
Modifications include, but are not limited to:
- Modification in the cylinder capacity;
  - Changing the type of fuel permitted;
  - Introducing or increasing a minimum weight;
  - The provision of new standards regarding hulls; or
  - By other means as determined by The Association.

## **501.03 ENGINE/HULL CLASSES - RECORD CLASSES**

### **INBOARD SECTION**

Unlimited Hydroplane	A/Asian	Aust	State
Unlimited Displacement	A/Asian	Aust	State
Unlimited Side Valve Displacement		Aust	State
Unlimited Unblown Displacement		Aust	State
Grand Prix Hydroplane	A/Asian	Aust	State
Blown Lite Displacement		Aust	State
7500cc Hydroplane	A/Asian	Aust	State
7500cc Displacement	A/Asian	Aust	State
6000cc Hydroplane	A/Asian	Aust	State
6000cc Naturally Aspirated Displacement	A/Asian	Aust	State
6000cc Carburettored Cast Iron Displacement		Aust	State
Pro Stock <i>(formerly 6000cc Restricted Displacement)</i>		Aust	State
5200cc Hydroplane	A/Asian	Aust	State
5200cc Naturally Aspirated Displacement	A/Asian	Aust	State
5200cc Carburettored Cast Iron Displacement		Aust	State
4600cc Hydroplane	A/Asian	Aust	State
4600cc Displacement	A/Asian	Aust	State

4600cc Side Valve Displacement		Aust	State
4.2 Litre Stock Hydroplane		Aust	State
4.2 Litre Stock Displacement		Aust	State
3750cc Hydroplane	A/Asian	Aust	State
3750cc Displacement	A/Asian	Aust	State
2750cc Hydroplane	A/Asian	Aust	State
2750cc Displacement	A/Asian	Aust	State
1750cc Hydroplane	A/Asian	Aust	State
1750cc Displacement	A/Asian	Aust	State
1.6 Litre Hydroplane - Restricted Motor		Aust	State
1.6 Litre Displacement - Restricted Motor		Aust	State
1250cc Hydroplane	A/Asian	Aust	State
1250cc Displacement	A/Asian	Aust	State
850cc Hydroplane	A/Asian	Aust	State
850cc Displacement	A/Asian	Aust	State

#### OUTBOARD SECTION

"C" Class Hydroplane	A/Asian	Aust	State
"D" Class Hydroplane	A/Asian	Aust	State
"F" Class Hydroplane	A/Asian	Aust	State
Unlimited Hydroplane	A/Asian	Aust	State
25 HP Open Hull		Aust	State
Yamato OSY400A Open Hull		Aust	State
800cc Open Hull		Aust	State
1250cc Open Hull		Aust	State
2100cc Super Stock		Aust	State
Unlimited Outboard Open Hull	A/Asian	Aust	State
800cc Mono Hull		Aust	State
1250cc Mono Hull		Aust	State
1800cc Mono Hull		Aust	State
2100cc Mono Hull		Aust	State
Unlimited Capacity Stock Motor Mono Hull		Aust	State
Unlimited Capacity Mono Hull		Aust	State
Mod VP Class		Aust	State
550cc Super Sports		Aust	State
1250cc Super Sports		Aust	State
1800cc Super Sports		Aust	State
2100cc Super Sports		Aust	State
2700cc 4 Carby Restricted Super Sports		Aust	State
<b>Formula 1</b>	A/Asian	Aust	State
<b>Formula SST120</b>		Aust	State
<b>Formula 3</b>		Aust	State
<b>Formula 4</b>		Aust	State
<b>Formula 2</b>		Aust	State

## INFLATABLE SECTION

P750	Aust	State
P750 Modified	Aust	State

## OFFSHORE SECTION

Class 1	Aust	State
Supercat 1000	Aust	State
Supercat 600	Aust	State
Supercat 400	Aust	State
Super Vee	Aust	State

## 502 COURSES

- 502.01 The course must be surveyed by a Qualified Surveyor, who must also prepare a Certified Chart of the Course, copies of which must be lodged with the Council and The Association.
- 502.011 The Certified Chart must indicate a measured base line, permanently marked, together with sufficient relevant survey data to enable the reestablishment of the course and all timing marks in the event of their destruction.
- 502.02 The length of the course for Speed Trials and Special Record Attempts is to be of either one (1) Kilometre, one (1) Statute Mile, or one (1) Nautical Mile.
- 502.03 The length of the course for Time Trials is to be one Quarter Mile (402.38 metres).
- 502.04 The start and finish lines of the course must be at right angles to the line of the course and each line must be clearly marked with two (2) permanent markers fixed in solid ground.
- 502.041 The timing marks must be located in such positions that accurate timing of Boats is ensured and any course that in the opinion of the Council or The Association is not marked accordingly will be rejected.
- 502.042 Buoys are not permitted as timing marks under any circumstances but can be used to indicate the running line of the course, provided they are located well clear of the start and finish lines.

## 503 TIMING

- 503.01 Timing must be carried out by competent timekeepers using timing devices approved by The Association.
- 503.011 The timing devices used must have a first class certificate issued either by a certified watchmaker, Observatory or similar Authority.
- 503.012 The Certificate must not be older than two (2) years, and a copy must be forwarded to The Association.
- 503.02 Timing is to be to one hundredth of a second accuracy.  
The two timing stations must be in communication by an electrical apparatus, with or without wire.
- 503.03 Timing is not permitted from boats or floating platforms of any type or description.
- 503.04 The start of each trial must be 'flying' and the time taken as the bow of the Boat crosses the line.
- 503.05 Each Boat must make two (2) consecutive runs, one in each direction, and in such order as determined by the Race Committee.

## 504 METHODS of TIMING

Timing must be by one of the following methods

- 504.01 **ONE-WAY TIMING – with the two stations in communication by electrical apparatus, with or without wires.**
- 504.011 A timekeeper and another Official are stationed at each end of the course.
- 504.012 As the Boat crosses the starting line the timekeeper at that position, sets the stopwatch in motion and at the same time gives a signal to the finishing line by the electrical apparatus, in response to which the timekeeper at the finishing line also sets a stopwatch in motion, thus both watches start together.
- 504.013 When the Boat crosses the finishing line, the timekeeper at that position stops the watch, and at the same time gives a signal to the timekeeper at the starting line in response to which the latter stops the watch.
- 504.014 Immediately the watches have been stopped, the timekeepers' record the times shown, and the time of day, on the timing sheets. If there is any difference in the times recorded by each watch, the arithmetical mean is taken as the time of the run.

- 504.015 The same procedure applies for the return run.
- 504.016 It may be arranged for the stopwatches to be set in motion by means of an electromagnetic device operated by the officials at the two positions. The two watches can then be placed at the one station, and the time recorded by one person.
- 504.018 Should one of the watches at either end fail to register a time, the time registered by the other watch will hold good, but the occurrence must be recorded on the timing sheet.
- 504.02 ONE WAY TIMING - with Synchronised Watches**
- 504.021 Timing can be carried out using synchronised watches - two at each end of the course (a total of four watches).
- 504.022 As the Boat crosses the start and finish lines, the time showing on the each of the watches is recorded.
- 504.023 If there is any difference in the times registered by the watches at each end, the arithmetical mean is taken as the time.
- 504.024 The difference between the times registered by the watches at each end is the time of the run.
- 504.025 The same procedure applies for the return run.
- 504.03 LOOP TIMING**
- 504.031 Timekeepers are stationed at each end of the course.
- 504.032 The timekeepers at the Run in end (starting end) start the watches as the Boat crosses starting line, and stop the watches as the boat re-crosses the line at the end of the return run.
- 504.033 The mean of the times registered is the TOTAL time of the trial.
- 504.034 The timekeepers at the Loop end (finish end) of the course start the watches as the Boat crosses the finish line, and stop the watches as the boat re-crosses the line at the commencement of the return run.
- 504.035 The mean of the times registered is the LOOP time of the trial.
- 504.036 Should one of the watches at either end fail to register a time, the time registered by the other watch will hold good, but the occurrence must be recorded on the timing sheet.
- 504.037 The ELAPSED time for the two consecutive runs is the difference between the TOTAL and LOOP Times.
- 504.038 The times registered by each watch for every run, and the time of day for each run must be recorded on the timing sheets.

## **505 CALCULATION OF SPEEDS**

- 505.00 Speeds are to be calculated for both kilometres and miles per hour.
- 505.001 The formulas to be used for calculation of speeds over a course of one kilometre are shown.
- 505.01 **FOR ONE-WAY TIMING METHODS** - The SPEED for each run must be calculated from the times recorded and using the formula shown.
- 505.011 The SPEED of the TRIAL is the arithmetical mean of the SPEEDS of EACH RUN, corrected to two decimal places.
- |   |           |  |
|---|-----------|--|
| <b>Speed (MPH) = <math>\frac{2236.936284}{\text{One Way Time (seconds)}}</math></b> | <b>or</b> | <b>Speed (KPH) = <math>\frac{3600}{\text{One-Way time (seconds)}}</math></b> |
|---|-----------|--|
- 505.02 **FOR LOOP TIMING METHOD** - The SPEED of the TRIAL must be calculated using the ELAPSED TIME and the formula shown, corrected to two decimal places.
- |  |           |  |
|--|-----------|--|
| <b>Speed (MPH) = <math>\frac{4473.8752568}{\text{Elapsed Time (seconds)}}</math></b> | <b>or</b> | <b>Speed (KPH) = <math>\frac{7200}{\text{Elapsed time (seconds)}}</math></b> |
|--|-----------|--|

## **506 MARGINS**

- 506.01 A new Speed Record is only valid if the speed achieved at least equals the existing record speed multiplied by 1.0075.
- 506.02 A new Time Record is only valid if the time achieved is not greater than the existing record time multiplied by 0.9925.

## **507 INTERVALS and INTERRUPTIONS**

- 507.01 The time elapsing between consecutive runs of any Boat must not exceed twenty (20) minutes except for 'jet' or 'rocket' powered Boats where the duration can be one (1) hour.
- 507.02 A Boat must not leave the course before the two runs are completed without the consent of the Officer of the Day.
- 507.021 The Driver is permitted to stop the motor between the two runs of the trial.

- 507.03 There must be no change in the hull and/or motor plant during the trial.
- 507.031 Minor changes and adjustments are permitted.
- 507.04 A Boat that fails to cross the finishing line of any one run is to be permitted the privilege of a restart.

## **508 ELIGIBILITY TO CLAIM**

- 508.01 In all Outboard Classes, claims for Speed or Time Records will only be accepted after a State or Australian Championship for the motor/hull Class has been contested.
- 508.02 Offshore Class claims for Speed Records must be accompanied by a copy of the results in which the said Boat was classified first, second or third in an Offshore Championship Race.
- 508.03 Where a Boat is eligible to compete in more than one engine and/or hull Class, it must make a separate run for each record claimed.
- 508.031 The Unlimited Class Record however can be claimed in conjunction with the same hull Class record achieved.
- 508.032 The Competitors right to claim the Australasian, Australian or State Records for the one engine Class for that hull is not affected.
- 508.04 A Boat, having broken an existing Record for Speed or Time on the day for a Class will be entitled to a Certificate for Speed or Time, even if the Speed or Time is bettered by another Boat before the conclusion of the Trials or Special Record Attempt.
- 508.041 In the event of more than one Boat having equal speed or time and still breaking a Record, each Boat will be entitled to appropriate Certificates.
- 508.05 Where a Record for a new Class has not been previously established, the Record will be deemed to be established by the fastest Boat in such Class on that day.
- 508.06 In respect of claims for State Records, the entrant may claim the speed or time established in another State providing the entrant is a full member of Club in the state for which the State Record is being claimed, and with that Council's prior approval.
- 508.07 The onus is on the entrant to ensure that all claim forms are completed and to comply with the requirements of Rule 702 concerning the sealing of motors and measuring of motors and lodgement of the certificate within the prescribed period of time.

## **509 SPECIAL RECORD ATTEMPTS**

- 509.01 A Club may make application to its respective Council for permission for a member to make a Special Record Attempt in a named Boat, at least four (4) weeks before the proposed attempt.
- 509.011 Such application must state the venue, date, time and possible duration of the attempt and the Club conducting the event.
- 509.012 The application must be accompanied by a signed statement from the Club Secretary that in the opinion of the Club Officials the Boat is capable of a speed within 10% of the speed of the Official Class Record being attempted and must nominate the existing Class Record Speed.
- 509.02 Special Record Attempts are limited to the Boat/s named in the application and no other Boat may participate unless it is with the concurrence of the original applicant/s as to participation, order of running, and share of costs, if any.
- 509.021 The Boat Owner makes application to the Council in accordance with these Rules, and through the Club originally applying.
- 509.03 The Council may authorise the attempt and must indicate the duration of validity of the permit and may require lodgement of a cash deposit from all or any of the applicants of an amount that it deems appropriate.
- 509.031 Where World, Australasian or Australian Records are to be attempted, the Council must give at least two (2) weeks notification of all details and Records to be attempted to The Association.
- 509.04 The Council will appoint Referees to supervise the attempts.
- 509.05 For Special Record Attempts, the Officials approved by the Council may receive payment for their services at rates fixed by The Association, such costs to be borne by the applicant/s.
- 509.051 The Council will refund deposits to applicants when satisfied that the obligation to meet costs has been satisfactorily discharged.

## **510 WORLD RECORD ATTEMPTS**

- 510.01 **RULES** - All World Record Attempts must comply with Union Internationale Motonautique (UIM) Rules for Class and Engine and UIM Group 600 Rules as contained in the UIM Rule Book current at the time of the attempt.
- 510.011 The Association should be contacted in order to purchase the current UIM Rule Book.
- 510.02 **APPLICATIONS** - All applications for World Record Attempts must be in writing by the competitor and submitted through the Council intending to conduct the attempt, to The Association.

- 510.021 The application must be in the hands of The Association at least two (2) weeks before the proposed date of the attempt, accompanied by the appropriate fee as specified in Rule 203.07.
- 510.03 **RESULTS** - Pending official confirmation of the UIM neither the Driver, Boat Owner, Boat builders, nor any person must publish or circulate the results of the trials until the appointed Officials of The Association have given the actual results in writing after verification of the calculations in the presence of the Timers.
- 510.031 Even when the Officials have given such verification, the results may only be published with the addition of the words, "Subject to Official Approval Certificate by the UIM", printed in as large and prominent type as any part of the notification itself is printed.
- 510.032 Neglect to comply with the above regulation automatically entails the refusal to recognise the record.
- 510.033 The Association has the right to penalise who-so-ever is responsible.

## **511 INTERCITY RECORDS ON OCEAN COURSES**

- 511.01 **CLASSES** - The Association recognises separate records on an Ocean course for the Classes listed in the Specific Offshore Rules of The Association only.
- 511.011 All accessories and/or equipment required for the racing of each class of boat attempting to establish a record must be on board during the attempt.
- 511.02 The start and finish lines in the various City Ports are established as follows:
- Sydney (Port Jackson):** An imaginary line between Hornby light in the inner South Head and flashing red beacon (Lady Game Beacon), west of Hornby light
- Brisbane:** An imaginary line off the Game Fisherman's wharf (approx. 15 Km from mouth of Brisbane River) on North bank - approximately 3 Km from Brisbane.
- Melbourne (Port Phillip):** An imaginary line extending 200 metres off St. Kilda pier, Port Phillip Bay.
- Hobart (Derwent River):** An imaginary line off Castray Esplanade, Hobart
- Adelaide:** An imaginary line off south side of the Glenelg Pier.
- Launceston:** An imaginary line from the centre of the lighthouse on Low Head, the eastern headland of the Tamar River entrance, to the Hebe Reef marker as shown on Aus 167 Hydrographic chart and bearing approx. 278° (Magnetic) from the Low Head light.
- GOLD COAST to CAIRNS:** Will be recognised, with the following stops permitted. A record will only be permitted for the entire course, and the time recorded will be the "on water" time, with the stops at the listed ports being deducted from the total time. A time limit of 22 days (average days per stage) is allowed to complete the course.
- Gold Coast:** A line bearing 90° (magnetic) from the seaward end of the southern breakwater of the Gold Coast seaway.
- Mooloolaba:** A line bearing 40° (magnetic) from the north-eastern corner of the Newport Apartments tower block.
- Noosa:** A line bearing 0° (magnetic) from the southern end of the eastern breakwater to the Noosa River entrance.
- Hervey Bay:** A Line bearing 90° (magnetic) from the northern end of the southern breakwater of the Urangan Marina.
- Bundaberg:** A line bearing 0° (magnetic) from the landward end of the upstream breakwater of the Burnett Heads boat harbour.
- Gladstone:** A line bearing 10° (magnetic) from the western end of the Auckland Point wharf.
- Rossllyn Bay:** A Line bearing 45° (magnetic) from the seaward end of the eastern breakwater of the marina.
- Mackay:** A line bearing 80° (magnetic) from the southern tip of the northern breakwater of the Outer Harbour.
- Hamilton Island:** A line bearing 160° (magnetic) from the southern tip of the northern breakwater of the marina.
- Townsville:** A line bearing 55° (magnetic) from the north eastern corner of the Ambassador Motel at 75 The Strand.
- Cairns:** A projection of the centre line of the Marlin Jetty in Trinity Inlet.
- 511.03 At least fourteen (14) days notice must be given to the Driver or Boat Owner's Council of the intention to make a Record attempt and a deposit of one thousand dollars (\$1000) must be lodged with the Council at the time of notification.
- 511.04 The Boat Owner and or Driver must satisfy the Council of the competency of the navigator.
- 511.05 The Boat Owner or representative of the Boat owner must make arrangements for a suitable boat to be at the disposal of the appointed Officials at the start and finish of the record attempt in the respective ports if required.

- 511.06 The Boat Owner must give twelve (12) hours preliminary notice of estimated departure and arrival times and four (4) hours notice of intended departure time.
- 511.061 Officials are not required to remain at the point of departure or finishing point for more than two (2) hours.
- 511.062 If the Boat arrives after the expiration of the two (2) hour limit, the arrival time will be taken as the time of arrival at the finishing point of the newly appointed Official.
- 511.07 The Boat Owner must meet the following expenses; - payment for time, at the rate of \$40 per hour, spent by Council appointed Officials in travelling from home or place of employment to competitor's departure and arrival point and return, waiting time, and out-of-pocket expenses incurred by Council/s and appointed Officials, e.g.: phone calls.
- 511.08 The Council will refund the balance of the deposit to the competitor when satisfied that the obligations to meet associated costs have been satisfactorily discharged.
- 511.09 In addition to any other listed equipment to be carried, an adequate supply of fresh drinking water in unbreakable containers and "hard rations" for at least seven (7) days must be carried.

## **512 SPEED ACHIEVEMENT AWARDS**

- 512.01 **100 MPH and 200 KPH BADGES** - A Speed Achievement Award can be claimed by a Driver on the first occasion that **100 MPH or 200 KPH** is exceeded in a Boat driven by them over a kilometre course under Speed Trial conditions as per Group 200 and 500 Rules.
- The Driver has the option of claiming the badge.
  - Only one claim is permitted per particular Boat in any one season, with the exception of Boats in Offshore Section where claims can be permitted by the Driver and Riding Crew as defined by Rule 205.04.
  - The 100 MPH badge can be claimed simultaneously with the 200 or 300 KPH Badge.
- 512.02 **300KPH BADGE** - A speed achievement badge can be claimed by a Driver on the first occasion that **300 KPH** is exceeded in a Boat driven by them at sanctioned Speed & Time Trials or Drag Section Events. Claimants must comply with all Group 200 and 500 Rules and Drag Class Rule 1315.
- EXCEPT:**
1. if over a Kilometre or Quarter Mile course and the one-way speed exceeds 300 KPH but not the speed of the trial, this badge can be claimed
  2. If at a Drag Class Event and 300 KPH (Terminal Speed) is exceeded, a back up run is not required.
- 512.03 Only one claim per particular Boat in any one season, with the exception of Boats in the Offshore Section where claims can be permitted by all drivers by Rule 205.04.
- 512.04 The badge can be claimed simultaneously with other badge or record claims.
- 512.05 The requirements of the other claims must be complied with otherwise the other claims will be declared invalid.
- 512.06 The Driver has the option of claiming the badge but if the option is exercised, another badge claim cannot be made in that season.



## GROUP 600 – COURSES

- 601 CHAMPIONSHIP COURSE SPECIFICATION
- 602 BUOYS
- 603 RIGHT OF WAY
- 604 OVERLAP
- 605 OVERTAKING
- 606 GENERAL
- 607 COURSE DIAGRAM
- 608 PENALTIES

### 601 STANDARD CHAMPIONSHIP COURSE

- 601.01 The Championship Course for Inboard and Outboard Classes must be made up of the following:
- Lap length between 1.8 and 2.4 kilometres (including turns)
  - A turning radius of between 25 and 60 meters
  - Not less than 90 meters of clear water on either side
  - The turning radius clearly marked.
  - The minimum number of buoys permitted on each turn is three (3), unless changes have been approved by The Association (Rule 601.05).
- 601.02 The length of the Course must be measured in straight lines from the outside of the turning buoys to the outside of the turning buoys.
- 601.03 Both ends of the starting line must be clearly marked and the starting line must be of sufficient length to permit all Boats to start abreast without interference.
- 601.04 The finishing line must be at right angles to the line of the course and be in line with the judges' stand.
- 601.05 A Council may submit an alternative course to The Association for approval if circumstances warrant such action under Rule 301.01.
- 601.06 The Race Committee may, with the Referee's approval; change the course, provided notice of such change is given to each Driver and Boat Owner before the start of the Race.
- 601.07 The Course must be laid down ready for inspection at least one (1) hour before the official starting time of the event and inspected by the Referee who must certify that all buoys, marks, etc. are in position.
- 601.08 The Club vested with the control of the Event must ensure that the Course and the competitors thereon do not contravene any Regulations as laid down by an authorised body such as the SBA, Police, or Local Government etc.

### 602 BUOYS

- 602.01 Buoys are to be used to indicate the racing course.
- All buoys must be of a colour readily distinguishable from the surrounding background.
  - Any day-glow red buoys used must be of conical appearance.
  - The minimum size of marker buoys must be 780mm diameter at the waterline, 1220mm high, and 304mm diameter at the top.
  - Balloon type marker buoys made of plastic or heavy rubber material are acceptable provided that such buoys are a minimum of 1220 diameter and coloured yellow.
  - Buoys must be "user friendly". It is recommended that fibreglass, concrete or hard piles not be used.
- 602.02 The lead in buoy on every three buoy turn must be distinguished from the other two by:
- being larger, or;
  - a different colour, or;
  - a flag or balloon floating above the buoy.
- 602.03 Should a buoy be moved from its proper place during a Race, it should, if possible be replaced. However, if this is not possible the Race Committee may at its discretion order the Race to be re-run.

602.04 The Race Committee may at its discretion lay buoys or markers around the Course to indicate shoals or other underwater obstructions provided such buoys or markers do not encroach on the minimum stipulated width of the Course.

### **603 RIGHT OF WAY**

- 603.01 All buoys must be passed on the left side of the Boat, unless otherwise stipulated during the drivers briefing.
- 603.02 A Boat that touches a buoy during a turn will incur a one-lap time penalty for each infringement.
- 603.03 If in the consideration of the Officer of the Day or buoy Official, a Boat is forced onto a buoy by another Boat, no penalty will be implemented.
- 603.04 A Boat that rounds a buoy the wrong way will incur a one-lap time penalty for each infringement.
- 603.05 For safety reasons, a Boat is not permitted to round the buoy again after rounding it the wrong way. A Boat is considered as having rounded the mark in a wrong way when the buoy Official considers that it has passed the buoy on the wrong side after starting to negotiate the turn.
- 603.06 A Boat that attempts to re-round a buoy will be disqualified.
- 603.07 The cost of repair or replacement of any buoy damaged in a collision is to be borne by the Boat Owner of the Boat causing such damage.
- 603.08 When two Boats are approaching one another so as to involve risk of collision, one of them must keep out of the way of the other as follows;
- When two Boats meet head on, each must alter the course to the right side.
  - When two Boats are crossing, the one that has the other on its right side must give way.
  - Whereby any of these Rules one of the two Boats is to give way, the other must keep its course and speed.
  - Every Boat that is directed by these Rules to give way to another Boat must, if the circumstances of the case permit, avoid crossing ahead of the other.
  - Every Boat that is directed by the Rules to give way to another Boat must on approaching it, if necessary, reduce its speed or stop.
  - When obeying these Rules, due regard must be made to all dangers of navigation and collision, and to any special circumstances that may render a departure from the above Rules necessary in order to avoid immediate danger.
- 603.09 Failure to comply with 603.08 will result in a one-lap time penalty for each infringement.

### **604 OVERLAP**

- 604.01 An overlap is established when two Boats are on the same course or approximately on the same course and the overtaking Boat no longer has a free choice on which side it will pass.
- 604.02 When one of two Boats is obliged to keep clear, the other must not alter its course so as to involve the risk of fouling.
- 604.03 A Boat must not bear out of its course so as to hinder another in passing.

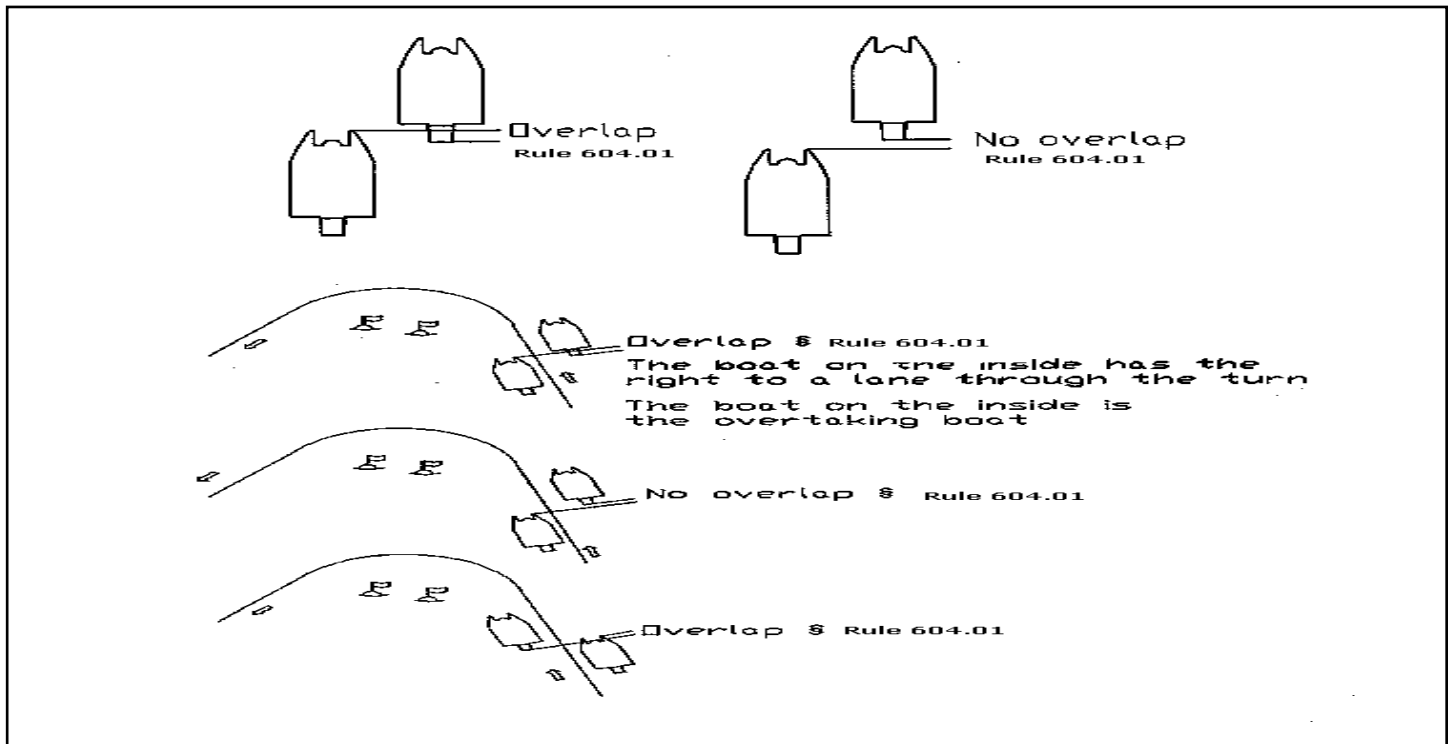

Examples of Overlapping

**605 OVERTAKING**

605.01 An overtaking Boat must keep clear of the Boat being overtaken.

605.02 The overtaking Boat must allow at least **three** boat lengths in the direction of travel, before altering course. Failure to comply will result in Disqualification from that Race.

**605.03 OVERTAKING IN TURNS**

605.031 When trying to overtake a Boat on the inside, the Driver must foresee the direction of the Boat being overtaken and take all the necessary precautions including stopping the Boat in order to avoid a collision.

605.032 When passing a buoy and an overlap has been established between two Boats when both of them are about to pass a buoy on the required side, both Boats must maintain their lanes, i.e. they must maintain their distance from the buoy until the buoys has been rounded.

Failure to comply will result in Disqualification from that Race.

605.033 A Boat is not justified in attempting to establish an overlap by forcing a passage between another Boat and a buoy at a turn after the latter Boat has altered course for rounding the buoy.

Forcing passage will result in disqualification from that Race.

605.034 Overlapping while overtaking does not give priority to the Boat overtaking on the inside.

**606 GENERAL – Sections I, O and FF**

606.01 Boats and/or appropriate facilities must be provided in appropriate positions for the use of course Officials and Referees. Referees are empowered to specify or advise appropriate positions.

606.02 A Driver or Boat must not receive **physical** outside assistance during the running of a Race, except in the case of an accident.

606.03 Drivers or Boats failing to comply with any of the instructions contained in these Group 600 Rules will be Disqualified from the Race, unless another penalty is specifically indicated.

606.04 After a Boat has completed a Race, it must slow down and safely round the next course buoy and await the Black Flag before returning to the Pit Area. Failure to comply will result in result in disqualification.

606.041 Further instructions can be specified by the Race Committee.

606.05 Every Driver and Riding Crew must render all possible assistance to any Boat, Driver, Riding Crew or person in peril and, if in the opinion of the Race Committee, the Boat has impaired its chance of winning by giving such assistance, the Race Committee may order the Race to be re-run between such Boats and the winner of the Race.

606.06 In the event of an incident on the course, any Boat travelling at speed past the scene of an incident while under Red Flag conditions will be disqualified from that Race.

**STANDARD COURSE DIAGRAM**

For Circuit Racing (not to scale)

Total distance around course 1800 to 2400 Meters

With not less than 90 Meters of clear water either side.

● = Position of Turn Buoys  
More bouys may be used where needed

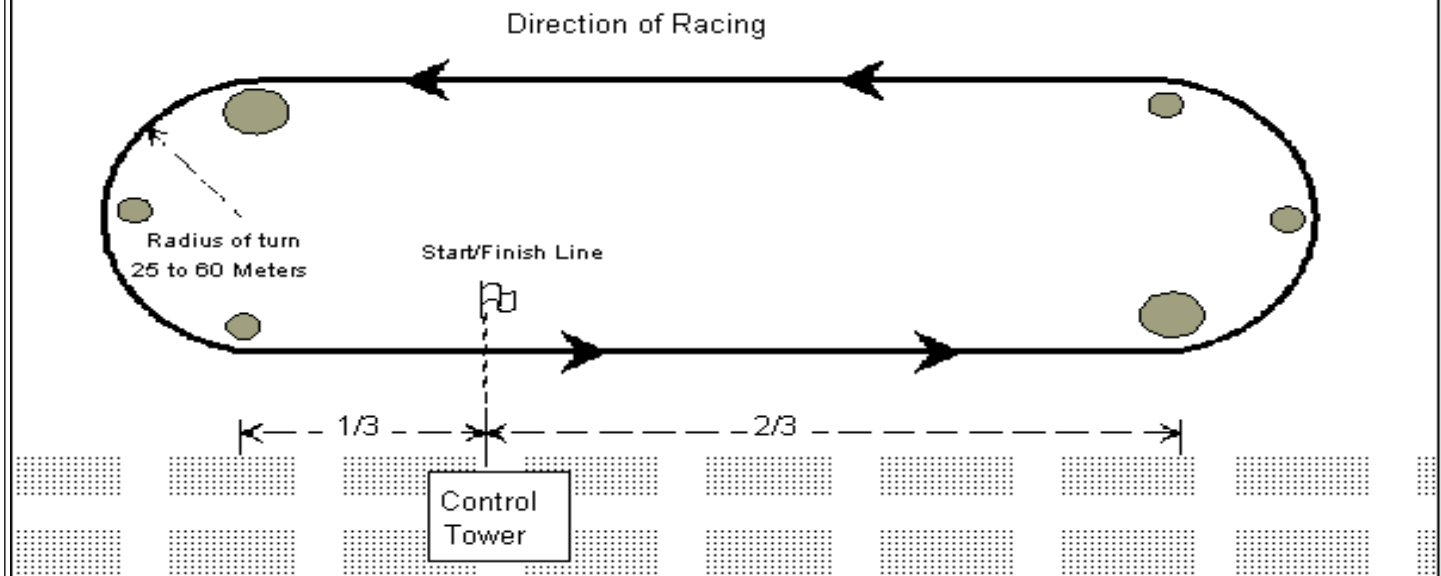
**PENALTIES**

<b>Touching or incorrectly rounding a turn buoy</b>	1 Lap Time Penalty for each infringement
<b>Attempting to re-around a turn buoy</b>	Disqualification from Race
<b>Damage to turn buoy</b>	Cost of replacement or repair to buoy
<b>Not having 3 boat lengths before overtaking</b>	Disqualification from Race
<b>Failure to maintain lane in turn when overtaking</b>	Disqualification from Race
<b>Forcing passage during a turn</b>	Disqualification from Race
<b>Failure to establish an overlap (604.01 to 604.03)</b>	1 Lap Time Penalty for each infringement
<b>Failure to comply with right of way (Rule 603.08)</b>	1 Lap Time Penalty for each infringement

# GROUP 700 – ENGINE MEASURING AND FUEL CHECKS

## 701 ENGINE MEASURERS

## 702 ENGINE EXAMINATION AND SEALING

## 703 FUEL CHECKS

### 701 ENGINE MEASURERS

- 701.01 On the recommendation from the respective Council, The Association will appoint a Senior Engine Measurer for each Council, whose responsibility will be to examine all other Engine Measurers, in regard to their qualifications before being recommended for appointment to the respective Councils.
- 701.11 **For Offshore classes** - On the recommendation from the Offshore Council, The Association will appoint "Offshore Measurers" who will be eligible to measure Boats in Offshore Classes only.
- 701.12 Sealing Pliers will be procured for purposes of sealing engines and must be of standard design bearing the inscription APBA, the Council of origin, and a number. Councils are responsible for the issue of such pliers and must keep a strict record of their issue.

### 702 ENGINE EXAMINATION AND SEALING

#### NO AUSTRALIAN POWER BOAT ASSOCIATION OFFICIAL IS PERMITTED TO SEAL ANY ENGINE THAT IS NOT IDENTIFIED BY A SERIAL NUMBER OR MARK

- 702.01 Unlimited classes in the Inboard and Outboard Sections are not required to be sealed.
- 702.02 The Referee may at any time during the conduct of an Event, request to inspect any Boat or associated engine for identification only.
- 702.021 An engine will not be required to be dismantled before the start of any Event.
- 702.03 Any Boat after winning a Championship, or a Round of a Championship if being conducted as a Series or establishing a Record must have the engine sealed immediately after the Event by the appointed Engine Measurer or Referee.
- 702.030 The Referee may order such other Boats competing in the Event to have their engines sealed if deemed necessary.
- 703.031 Failure to comply with this Rule will automatically disqualify the Boat.
- 703.032 Clubs may require engine measurement and/or sealing for restricted capacity Club Events at their discretion.
- 702.04 Engines having been previously sealed by an appointed Engine Measurer, and where the seals are still intact, and the Boat Owner being able to produce a Certificate of Measurement which identifies the seal and motor (by number or mark), are not required to be resealed.
- 702.05 All Boats claiming a Championship, or a Round of a Championship if being conducted as a Series, or Record and not holding a Certificate of Measurement from an authorised Engine Measurer, must have the engine examined and measured and the certificate lodged to be received by the Council Secretary (or as otherwise instructed) within fourteen (14) days of the Event.
- 702.051 The onus is on the Boat Owner and Driver to ensure that the certificate is obtained and lodged within the fourteen (14) day period. Failure to comply with this rule will automatically disqualify the Boat.
- 702.06 *Mr Gasket* (or similar) measuring equipment is recognised as a device for measurement of engine capacity and if the capacity measured is under the Class capacity it is accepted as a capacity measurement.
- 702.061 The *Mr Gasket* (or Similar) equipment must not be used for determining the engine capacity for the purpose of sealing an engine and issue of a Measurement Certificate, except in the Grand Prix Hydroplane Class.
- 702.062 The use of the *Mr Gasket* (or similar) equipment is restricted to four (4) cycle type engines.
- 702.07 A Council may at their discretion accept a Statutory Declaration from a recognised and competent motor engineer who has personally examined and measured the engine and supplied the measurements of the bore and stroke of each individual cylinder and such other specifications as required by the Senior Engine Measurer.
- 702.08 At least two (2) days prior notice must be given to an Engine Measurer of a request to examine and measure an engine at a time other than the day on which the Event was conducted.
- 702.09 Engine Measurers are not permitted to measure or examine and seal the engine of a Boat in which they have an interest, or against which they may compete.
- 702.10 The Boat Owner of the engine being presented for examination, measuring and sealing is responsible for ensuring that the engine has some form of marking to allow for future identification.

- 702.11 It is the responsibility of the Boat Owner to supply the Engine Examiner with the specifications for the motor being examined and measured.
- 702.12 There must be no charge for engine examining measuring.

### **703 FUEL CHECKS**

- 703.01 Samples of the fuel, of measurable quantity, directly from the fuel system of a Boat after the Championship or Trial are to be taken and checked for compliance with the Rules.
- 703.011 Rule 703 can be waived by the Referee, Drag Boat Race Director or the Offshore Council for Championships or unsuccessful Record attempts.
- 703.02 A Fuel Check Committee may be formed at an Event and will consist of any three of the following person not having an interest in the Boat being checked:
- A member of the Executive of The Association, a Council Delegate or Engine Measurer
  - An Australian or State Referee
  - A Club Official or Scrutineer
  - A Boat Owner or Driver from another Class
  - A Club member with an industrial knowledge of fuels or chemicals
- 703.03 Where the Fuel Check Committee is unable to make a unanimous decision on the legality or otherwise of the fuel or not enough qualified people can be found, they will seal the sample for later examination under supervision of The Association.

## GROUP 800 – SAFETY

- 801 DRIVER APPAREL
- 802 EQUIPMENT FOR DRIVER PROTECTION
- 803 DRIVER SIGNALS
- 804 HULLS AND MACHINERY
- 805 LOG BOOKS
- 806 RESCUE AND SAFETY SERVICES
- 807 INCIDENT REPORTING
- 808 FORMULA FUTURE DRIVER SAFETY ORIENTATION

### 801 DRIVER APPAREL

All apparel listed in following 801 Rules must be secured in the manner intended by the manufacturer and must be worn at all times whilst aboard the boat on the water.

#### 801.01 Personal Floatation Device (PFD) - For Inboard, Outboard, Formula Future, Pneumatic and Offshore Section Boats not fitted with a Reinforced Cockpit

801.011 All Drivers and Riding Crew not restrained in a Reinforced Cockpit must wear a non-inflatable waistcoat type PFD during each Race. The condition of the PFD must be checked and approved by the Scrutineer.

801.012 The PFD must have webbing straps, effective leg straps and be manufactured to a standard and of a type acceptable to the SBA or other competent authority for the type of boat being driven.

**The Association endorses the use of PFD's manufactured and labelled as meeting the American Power Boat Association std 'A-100' for open cockpit boats if the design is of a body suit style or fitted with leg straps.**

The Association endorses the use of PFD's manufactured and labelled as meeting the American Power Boat Association std A-100 if the design is of a body suit style or fitted with leg straps.

801.013 All parachute-equipped PFDs must be returned to the manufacturer or its agent at least every two (2) years for recertification.

801.014 All parachute-equipped PFDs must be returned to the manufacturer or its agent for repacking and recertification after being deployed.

#### 801.02 Personal Floatation Device (PFD) - for Inboard, Outboard and Offshore Section Boats fitted with a Reinforced Cockpit

801.021 All Drivers and Riding Crew restrained in a Reinforced Cockpit must wear a waistcoat or suit-type PFD, which may be of an inflatable type, during each Race. The condition of the PFD must be checked and approved by the Scrutineer. The PFD must have ballistic covering, be fitted with 4.5 kg (10 lb.) flotation and be equipped with epaulet type extraction loops on the shoulders and properly fitted to prevent being accidentally pulled over the head.

801.022 PFDs made specifically for use in Reinforced Cockpits are not acceptable for use in Boats without Reinforced Cockpits.

#### 801.03 Helmet - For Inboard, Outboard, Formula Future and Pneumatic Sections:

801.031 All Drivers and Riding Crew must wear an adequate Helmet during each Race.

801.032 The condition of the Helmet must be checked by the Scrutineer.

801.033 The Driver and Riding Crew are entirely responsible for the effectiveness of the Helmet worn by them.

801.034 The Helmet must be of International Orange or bright yellow in colour and the colour of the Helmet must contrast with the colour of the Driver's Boat.

801.0341 Driver's name will be permitted to appear on the helmet, which may appear once on the Helmet at the base at the front or rear of the Helmet and must be no larger than 20mm x 100mm in size.

801.0342 The area obstructed by a raised visor (or visor shield) may be excluded from the colour

**requirement**

- 801.0343** The helmet when viewed from the side, top, and rear must predominantly bear the hi visibility colour (orange or yellow). Eg. 50% or more must be the high vis colour when viewed from either side, top, and rear.
- 801.0344** Manufacturers logo may appear on side and/or rear while being no bigger than 30mm x 60mm. A race number may be applied in place of manufacturers logo (same dimensions)
- 801.035** The driver of the start boat, as well as the Starter, must wear a Helmet in accordance with Rules 801.03 section. It is not necessary for the driver or starter to comply with the 801.04 section. Offshore, and starts conducted from a Jet-Ski are exempt from this rule.
- 801.036** The driver of the start boat as well as the Starter must wear a PFD in accordance with Rules 801.011 and 801.012..
- 801.04** Helmet Restraints - for all Inboard, Outboard, Formula Future and Pneumatic Section Boats.
- 801.041** All Drivers and Riding Crew must use a Helmet restraint.  
The Helmet restraint must restrict movement of the head and secure the Helmet to the body or arms by straps or other means or a helmet restraint of a Leatt Brace style.  
In a reinforced Cockpit the helmet restraint must work in conjunction with the Safety Harness, like a Hans/NextsGen or similar style of device.
- 801.042** The Driver and Riding Crew are entirely responsible for the effectiveness of the restraint. 801.05  
Clothing - For All Sections:
- 801.051** All Drivers and Riding Crew must wear full-length clothing or race suits and wear boots or shoes during each Race.
- 801.06** Ballistic Pants - for Inboard, Outboard, Formula Future and Pneumatic Section Boats not fitted with a Reinforced Cockpit
- 801.061** All Drivers and Riding Crew, in addition to the protective clothing mentioned in 801.05, must wear pants (either long or short) made of a ballistic type material.  
Ballistic material can be manufactured from:
- Kevlar – a cut and abrasion resistant material
  - Spectra – a cut and abrasion resistant material
  - TUFF-*N*-LITE – the highest rated cut and abrasion resistant material
  - 1000 Denier Cordura Nylon – an abrasion resistant material
- 801.062** Formula Future Drivers are exempt from using pants (either long or short) made of a ballistic type material, however wetsuit shorts worn under the driving suit is required.

**802 EQUIPMENT FOR DRIVER PROTECTION**

- NOTE:** Rule 802 does not eliminate the need for the self-closing or “Dead-man” throttles that are mandatory for all Sections except Offshore.
- 802.01** For Inboard, Outboard, Formula Future and Offshore Sections
- 802.011** A Cut-Out switch approved by The Association must be fitted to the electrical system of all Boats except Boats fitted with a Reinforced Cockpit.
- 802.012** Such Cut-Out switches must be fitted in such a way that should the Driver or Riding Crew be ejected from their seat, the operation of the switch will automatically stop the engine/s and fuel pump/s.
- 802.013** The cord/s attached to the Cut-Out switch must also be attached to each Driver and Riding Crews’ PFD in a secure manner and the length of the cord must be limited so that the Driver or Riding Crew cannot move beyond the extremities of the Boat without activating the switch.
- 802.014** Approved Cut-Out switches are the types produced by the various outboard manufacturers and Nauti-Haul type switches.
- 802.015** For Inflatable Section - the Driver only needs to be connected to Cut-Out switch.
- 802.02** For Inboard Section – Fitted with Lap Restraint Belts.
- 802.021** The suitability and adequacy of any Lap Restraint Belt is the responsibility of the Driver and Riding Crew.
- 802.022** The Lap Restraint Belt must only pass over the Driver and Riding Crew’s waist or lower part of the hips and be fastened by means of a Velcro lapping of the straps.
- 802.023** No mechanical device or method must be used to lock the Lap Restraint Belt.
- 802.024** The ends of the Lap Restraint Belt must be marked with a fluoro yellow or orange tag.
- 802.025** A battery isolation or kill switch must be fitted to the port side of the rear deck.
- 802.026** All throttles must be returnable "dead stop".
- 802.03** For Inboard Section – Fitted with Deflection Bars.
- 802.031** The suitability and adequacy of any Deflection Bar is the responsibility of the Driver and Riding Crew



who should be satisfied that the Deflection Bar has been competently designed and constructed to a suitable standard to withstand an impact at speed.

802.04

The Driver of any Boat fitted with a Deflection Bar or Lap Restraint Belt must ensure that before the Boat enters the water at any Event, or official practice session, such equipment is inspected by the divers for familiarisation with the cockpit, release systems, and other pertinent matters.

- 802.05** While on the racecourse, all reinforced cockpit vessels (with a canopy) must keep their canopy lids secured and closed. Vessels not complying **may be issued with a Yellow Card**.  
Repeat offences **will** be issued a yellow card.
- Exceptions stand for:
- A vessel 'breaking down': when safe to do so, driver is to open canopy to signal race control.
  - Vessel transitioning from 'ramp' to 'racecourse' or vice versa: once onto the racing line (moving parallel with the course, within the boundaries of the course) the boat will be considered 'on the racecourse'.
  - Milling is not considered an exception.
  - **A single vessel participating in a club approved parade lap at the completion of a significant race is permitted to do so, with an open canopy to both signal the crowd and/or carry a flag.**
- 803 DRIVER SIGNALS  
for Inboard, Outboard and Formula Future Sections
- 803.01 In the event of an injury or serious accident the Driver and Riding Crew will not signal at all, thus indicating to Officials and Crash Boat Crews that immediate assistance is required.  
NOTE: Drivers in Boats fitted with a Reinforced Cockpit may not be able to signal
- 803.02 In the event of a Boat slowing down, the Driver must raise one arm and remain on course until all other Boats have passed.
- 803.03 In the event of a Boat losing steerage, (broken steering gear) the Driver must raise both arms.
- 803.04 In the event of a Boat being in difficulty and requiring immediate assistance, the Driver must stand and wave both arms.

## **804 HULLS and MACHINERY**

- 804.01 **For Inboard, Outboard, Formula Future and Offshore Sections** - All Boats must be inspected by a scrutineer and all covers removed for a closer inspection.
- 804.02 **For Inboard, Outboard, Formula Future and Offshore Sections** - All Boats must be fitted with a securely anchored towing eye (minimum 25mm ID.) at or near the bow and must be of sufficient strength to allow towing of the submerged Boat from the eye.
- 804.021** ***From start of 24/25 season: For Inboard Displacement Boats with Reinforced Cockpit – Vessels must have a rollover lift bracket or eyelet permanently attached to the rear top area of the cockpit and accessible in all configurations (not under a cowl etc.). The bracket or eyelet must have at least a 3/4" hole and be strong enough to support the weight of the boat should it need to be righted for rescue purposes.***
- 804.03 **For Inboard, Outboard, Formula Future and Offshore Sections** - No Boat is permitted to compete in an Event whilst fitted with a ski pole unless participating in a water ski Race.
- 804.04 **For Inboard, Outboard, Formula Future and Offshore Sections** - All Boats must have adequate floatation securely fitted or built in to assist floatation in the event of the Boat being swamped or submerged.
- 804.05 **For Inboard, Outboard, Formula Future and Offshore Sections** - Carburettors and throttle controls must be spring loaded to close at the engine. Rubber bands are not acceptable.
- 804.051** For vessels with 'fly by wire' or similar non-mechanically linked throttles - All vessels are required to prove throttle returns to closed with loss of power (electrical or hydraulic failure etc.) This is to confirm a 'power out' or 'failure' scenario for electric or hydraulically assisted/operated systems.  
Owners/Drivers are required to demonstrate this to technical inspectors at the time of inspection.
- 804.06 **For Inboard, Outboard, Formula Future and Offshore Sections** - All component parts of the Boat such as battery, fuel tank(s), hatches, etc. must be securely fastened to prevent movement.
- 804.07 **For Inboard, Outboard, Formula Future and Offshore Sections** - No fuel or oil residue is to be drained or pumped into waterways. In case of a mechanical failure, causing the loss of oil or fuel the Boat must not race again until the fault has been properly rectified.
- 804.08 **For Inboard, Outboard, Formula Future and Offshore Sections** - When in the Pit Area and the propeller is engaged, portable safety fences must be used around the stern of any Boat when the engine is running while the Boat is on the trailer. Alternatively, the propeller can be removed.
- 804.09 **For Inboard, Outboard, Formula Future and Offshore Sections** - Cable tensioning springs of any type are not permitted.
- 804.010 **For Inboard, Outboard, Formula Future and Offshore Sections** - The propeller-locking device fitted must be double nuts, split pinned, or Nylok nuts or a combination of these, excepting for manufacturer recommendations for inboard/outboard configuration.
- 804.0101 It is highly recommended that Nylok nuts be to be used once only then replaced.

- 804.11 **For Inboard, Outboard and Formula Future Sections** – It is the Boat Owner’s responsibility to provide the required access for inspection of the items covered in rules 804.12 through to 804.25.
- 804.12 **For Inboard and Outboard Sections** – Steering gear on Boats must be fitted with stops to prevent over-control.
- 804.121 For rod steering, the rods are to be sufficiently rigid to prevent undue flexing.
- 804.122 All nuts and bolts in steering linkages must be locked and/or pinned.
- 804.123 Steering cables must be locked and bends must be free and of sufficient diameter to prevent straining of bends and cable.
- 804.124** All vessels are required to have functional steering with engine turned off, and battery disconnected. This is to confirm a ‘power out’ or ‘failure’ scenario for electric or hydraulically assisted/operated steering systems. Owners/Drivers are required to demonstrate this to technical inspectors at the time of inspection.
- 804.14 **For Inboard Section** - The steering cable each side of the tiller arm on displacement Boats must be tied together with a second cable which must be clamped to the main steering cable on each side of the tiller arm and pass through and/or be tied or clamped to the tiller arm.
- 804.15 **For Inboard Section – All non-reinforced cockpit displacement Boats constructed after 1 January 2005, and fitted with cable steering, must be configured with all steering cables routed along the starboard side of the hull.**
- 804.16 **For Inboard Section** - A deflection shield, cover, or effective fixed guard must be fitted to prevent any part of the Driver or Riding Crew’s body or personal apparel or other equipment from becoming entangled in moving equipment within 300mm of the Driver or Riding Crew’s seat.
- 804.161 Such equipment would include, but would not be limited to:
- The drive shaft from the motor to the gearbox
  - The propeller shaft from the engine
  - The gearbox to the log
  - Any moving part exposed and adjacent to the Driver or Riding Crew’s seat
  - Any other moving part within 300mm vicinity of the Driver or Riding Crew
- 804.162 A deck cowling is not satisfactory unless it has a vertical shield extending to the engine bearer.
- 804.17 **For Inboard Section** - The rudder shaft must, in addition to the clamp bolt, have some type of locking device fitted to prevent the quadrant from rotating and or moving up the shaft.
- 804.18 **For Inboard Section** - The boss of the propeller must have at all times some clearance between the rear of the skeg.
- 804.181 The clearance between the boss of the propeller and the skeg must not exceed 1.5 times the major diameter of the shaft.
- 804.19 **For Inboard Section** - Where nothing else is provided, a base plate of at least the area of the skeg base must be placed inboard of the Boat and all skeg bolts must pass through this base plate and be double-nutted or fitted with nylon self-locking “Nylok” nuts.
- 804.20 **For Inboard Section** - A locking collar must be fitted to prevent the propeller shaft from sliding out of place.
- 804.201 The Boat Owner and Driver are entirely responsible for the effectiveness, suitability and adequacy of the locking collar.
- 804.21 **For Inboard Section Displacement Boats** – a retainer type device must be fitted between the clutch housing and the log so that in the event of gearbox or clutch-housing failure, the clutch housing will be prohibited from moving back so the propeller or propeller shaft does not move back far enough to hit the rudder.
- 804.211 The drive shaft must pass through this retainer type device with minimum clearance.
- 804.212 The Boat Owner and Driver are entirely responsible for the effectiveness, suitability and adequacy of the retaining device.
- 804.22 **For Inboard Section** - All engine-breathing hoses must terminate inside the Boat. It is recommended to have the breather hoses flowing into a catch tank.
- 804.23 **For Inboard, Outboard and Formula Future Sections** – Left and Right hand mirrors are permitted to be used. Mirrors must be effectively secured to the Boat.
- 804.24 **For Inboard Section** – Any chain, cable, rod or flexible coupling used to operate a gearbox or clutch must not impede the designed operation of the gearbox or clutch.
- 804.25 **For Inboard Displacement Classes** – Prior to first use, all cast only propellers must be x-rayed for flaws. Documentary evidence of the x-ray test must accompany each propeller and be available for inspection upon request.
- 804.26 **For Inboard Displacement & Drag Section Displacement Classes** – All Boats must be fitted with a ratchet-style gearbox release or free wheeling release, similar to an Algon/Stellings release, on

the propeller shaft or gearbox output shaft.

**804.261 Vessels while participating in Speed limited events/classes of 75mph and less, are exempt from rule 804.26.**

804.27 **For All Sections** – Any Boat Owner whose Boat is launched with the use of lifting slings must be in possession of a current (dated not more than 3 years prior) Fit For Purpose test certificate (or equivalent) for the lifting slings and the lifting slings must be tagged as suitable for the intended purpose. Overseas Boat Owners must provide equivalent documentation from the country of origin.

## **805 LOG BOOKS**

805.01 The Boat Owner must be in possession of a Log Book for each Boat owned by the Boat Owner.

805.011 Log Books are intended to record defects in the Boat over its competition lifespan and to assist Scrutineers in their duties.

805.012 Log Books should be maintained for the duration of the Boat's competition lifespan and be transferred with the Boat if it is sold.

805.013 The Race Committee or Scrutineer must report defects in the Boat, noted during Scrutineering or resulting from an incident, in the Log Book.

805.02 Driving infringements noted or cautions given during an Event are to be recorded in the appropriate section of the Driver's Rule Book.

## **806 RESCUE SERVICES**

806.01 Adequate water rescue services must be provided at all Events and official practice periods, including (but not limited to):

- Sufficient rescue or course boats;
- Divers and their equipment;
- Fire extinguishers;
- Ropes and;
- Marker buoys

### **806.02 AMBULANCE (outside a 10km RADIUS)**

806.021 Should the Event venue be outside a radius of ten (10) kilometre from an ambulance transport service, a fully equipped ambulance vehicle capable of carrying two stretchers and attended by a fully qualified Ambulance Officer must be in attendance at all Events and official practice periods.

806.022 An ambulance transport service means a Civil or Government or privately owned and operated ambulance service.

806.023 An Ambulance Officer would mean a Civil or Government or a private qualified Officer.

### **PLEASE NOTE: Rules 806.024 and 806.025 apply ONLY to the States of Victoria and New South Wales (Offshore events are exempt)**

806.024 At all Event venues in the State of Victoria and New South Wales, a minimum of two (2) fully equipped and experienced rescue divers and a minimum of one (1) fully experienced paramedic must be situated on the water at all times.

806.025 An ambulance transport vehicle – professionally equipped, capable of carrying stretchers and attended by fully qualified first aid officers – must be in attendance at all Events and all official practice period.

### **806.03 AMBULANCE (within a 10 km RADIUS)**

806.031 Should the Event venue be within a radius ten (10) kilometre from an ambulance transport service, an ambulance type vehicle need not be in attendance provided that: -

- The venue is in direct communication by telephone or radio with the ambulance transport service.
- A professionally equipped and qualified First Aid Attendants attends.
- Prior approval from the respective Council has been given.

### **806.04 RESCUE AND COURSE BOATS**

806.041 There must be a minimum of two rescue or course boats present on the course.

806.042 These boats should be positioned to minimise response time to an incident on the course.

806.043 Each rescue and course boat must carry a minimum of two persons.

806.044 Each rescue and course boat (including personal watercraft) must be equipped with fire extinguishers and salvage/tow ropes capable of supporting a submerged boat.



806.045 Tow ropes must be fitted with a quick-release type safety hook for easy attachment to the bow eye of the Boat.

806.046 Each course boat/duty boat must display an identification/safety flag as described:

- This flag must be triangular and orange in colour.
- The flag must be displayed at a minimum of 1.8 metres above deck level, in a position to be clearly visible.

#### **806.050 FIRE FIGHTING EQUIPMENT**

806.051 In addition to any fire fighting equipment supplied at a venue, it is recommended that all Boats include the following as part of their pit equipment:

- Minimum 20 Litre bucket of water (for use with methanol fuels)
- Minimum 4.5kg (ABE) Powder Extinguisher with current certification

806.052 Fire fighting equipment must be accessible at all times.

#### **806.06 DIVERS**

806.061 Before the start of each Event, divers must familiarise themselves with each Driver and Riding Crew's safety equipment and structural characteristics of each Boat.

806.062 Divers must be fully suited and ready to enter at any time a Boat is on the water.

806.063 The divers must be on official rescue boats and cannot be on the turn judge boats or moored boats.

### **807 INCIDENT REPORTING**

**807.00 IN THE EVENT OF A SERIOUS INCIDENT OCCURRING, THE FOLLOWING PEOPLE MUST BE ADVISED WITHIN 24 HOURS:**

- **THE PRESIDENT OF THE ASSOCIATION**
- **THE SAFETY OFFICER OF THE ASSOCIATION**
- **THE PRESIDENT AND SAFETY OFFICER OF THE RESPECTIVE COUNCIL**

**A serious incident includes, but is not limited to:**

- Injury and/or death to any Boat Owner, Driver, Riding Crew, volunteer or Official
- Destruction and/or substantial damage to a Boat or rescue boat.

807.01 Any Boat/s involved in an incident must be the subject of an Incident Report Form and Boat Report Forms, in the form prescribed by The Association. Such reports are to be completed by the Club or Council conducting the Event.

807.02 The Race Committee is to conduct an initial investigation within one hour of the incident where practicable or within one hour of the finish of the Event.

807.03 The completed Incident and Boat Report Forms are to be forwarded to the respective Council within fourteen (14) days of the incident occurring.

807.04 The Council will then forward a copy of the completed Incident and Boat Report Forms to The Secretary and The Association Safety Officer within twenty-one (21) days of the incident occurring.

807.05 Any Boat/s involved in an incident must remain in the Pit Area available for inspection by the Race Committee conducting the Event.

807.06 Unless requiring medical attention, the Driver and Riding Crew must also remain in the Pit Area to assist the Race Committee in its investigation.

807.07 Following an incident the Race Committee must issue a Yellow Card/s to the Driver/s held responsible for the Incident. The issue of said Yellow Cards is to be recorded in the Incident Report. If the Race Committee does not issue a Yellow Card, the race Committee must give reason.

### **808 FORMULA FUTURE DRIVER SAFETY ORIENTATION**

808.01 All Formula Future Drivers must complete a Formula Future Driver Safety Orientation held in conjunction with a Council approved Reinforced Cockpit orientation or other Council approved Event. The Formula Future Driver Safety Orientation must be overseen by a Council approved Reinforced Cockpit Orientation Supervisor, any Council Executive Member or Club Executive Member.

808.02 The Formula Future Driver Safety Orientation is designed to acquaint Formula Future Drivers, in a controlled environment, with situations where they may be immersed in water.

808.03 The Formula Future Driver Safety Orientation must be completed annually.

- 808.04 The Formula Future Driver Safety Orientation must include the following:
- The Driver must fall into the water in full race gear including race suit, shoes, PFD, Helmet and other apparel normally worn whilst racing.
  - The Driver must fall backwards into the water in full race gear.
  - The Driver must float in the water on his/her back in full race gear.
  - The Driver must, whilst in the water, attempt to dive under the water in full race gear.
- 808.05 The organisers and participants should feel that the Formula Future Driver Safety Orientation has been completed satisfactorily and that a feeling of confidence has been achieved by each Driver.
- 808.06 Each Driver competing in the Formula Future Classes is encouraged to participate in a Council approved Reinforced Cockpit orientation. Novice Drivers are exempt from this requirement.

# GROUP 900 – CONDUCT OF CHAMPIONSHIPS

- 901 GENERAL
- 902 START METHODS AND PROCEDURES
- 903 CLOCKS
- 904 SIGNALS AND FLAGS
- 905 START
- 906 RACE
- 907 WINNER
- 908 POINTS TABLE
- 909 HANDICAP RULES
- 910 CHAMPIONSHIP SERIES RULES

**NOTE:** Unless specifically noted at the beginning of each section, ALL RULES are applicable to Inboard, Outboard and Formula Future Sections

## 901 GENERAL

- 901.11 Unless conducted as a Series, a Championship will be contested over a number of Races within an Event, or should the number of entries warrant, the Championship may be contested over a number of elimination Heats and a Final. The purpose of the elimination Heats is to eliminate Boats until the predetermined number of fastest Boats is reached, who shall contest the Final.
- 901.12 Lane positions for Heat 1 (or Elimination Heats as described in Rule 901.11) may be drawn by ballot before or at the Briefing, or at the Race Committee's discretion, by utilising times recorded from Boats completing timed laps, no earlier than one (1) day before the Event.
- 901.121 Lane positions for Heat 2 may be drawn by ballot, before or at the Drivers' Briefing, or at the Race Committee's discretion they can be allocated utilising the finishing places from Heat 1.
- 901.13 When timed laps are used to determine lane positions, the Boat recording the fastest time will take lane position 1 (one) with the remainder on the outside in order of times.
- 901.131 In order to qualify for a Final, the fastest lap time of each Boat should be not more than 120% of the fastest lap time of the fastest qualifying Boat. (e.g. fastest qualifying boat = 40 second lap time – 120% = 48 seconds qualifying time) The Officer of the Day has discretion in this matter.
- 901.14 Late Entries, where permitted, are to be on the outside of the field.
- 901.15 A Driver may forgo his lane position and elect to start from the outside of the field. In the event of other Drivers making similar requests, a ballot for such positions must be held not less than thirty (30) minutes before the advertised starting time of the Event.
- 901.16 Non-Bona Fide entries will not be accepted. The Council decision as to the acceptance of entries is final.

## 902 START PROCEDURES and METHODS

- 902.10 **Inboard Section**
- 902.11 Boats will be under the direction of the Starter five (5) minutes before the scheduled start of each Race and must be behind the starting line.
- 902.12 **START BOAT STARTS** - Where the start of the race is to be by Start Boat, clear instructions as to the start procedure must be given to all Drivers at the Briefing.
- 902.121 These instructions must include: the course the start boat will follow, including the point at which boats must fall into line, where boats are to mill and the approximate speed of the start boat.
- 902.122 The driver of the start boat as well as the Starter must be present at the briefing.
- 902.123 The driver of the start boat as well as the Starter must wear a PFD in accordance with Rules 801.011 and 801.012.
- 902.124 All boats shall maintain their **lane** positions down the first straight from the drop of the flag until exiting the first corner. Failure to comply may mean disqualification.
- 902.13 It is recommended that when a start boat start is used, an Assistant Starter must be placed approximately one hundred (100) metres beyond the starting line and inside the course and will cause a flag to fall simultaneously with that of the Starter.
- 902.14 A clock start in accordance with the Outboard Procedure can be used as an alternative method of



starting.

## 902.20 **Outboard Section**

902.21 Flying Start races can be started by either Clock & Flag or Start Boat Flying Start (Rule 902.12).

902.22 Dead Engine Start Races can be started either by the fall of a Flag or by a Green Light.

902.23 Dead Engine Starts can be used in races longer than four (4) laps per heat.

## 903 **CLOCKS**

903.01 The clock must have a face of at least two (2) metres, the face painted yellow with black figures, and the pointer of the sweep hand only painted black.

903.011 The counterweight of the hand is to be the same colour as the clock face.

903.02 A Digital or Blackout type clock can be used as an alternative starting clock if approved by The Association.

## 904 **SIGNALS**

### 904.10 **FLAGS for Inboard, Outboard and Formula Future Sections – Flags used are:**

<b>BLUE PETER</b>	<b>3 MINUTES TO ZERO</b> <i>(for clock starts)</i>
<b>WHITE</b>	<b>IN THE HANDS OF THE STARTER</b> <i>(for Start Boat Starts)</i> <b>1 MINUTE TO ZERO</b> <i>(for clock starts)</i>
<b>WHITE FALLS</b>	<b>START OF RACE</b>
<b>GREEN</b>	<b>RACE IN PROGRESS</b>
<b>YELLOW</b>	<b>ONE LAP TO FINISH</b>
<b>BLACK and WHITE CHEQUERED</b>	<b>FINISH</b>
<b>BLACK</b>	<b>PERMISSION TO LEAVE COURSE OR RETURN TO PITS</b>
<b>RED</b>	<b>STOP</b> – for an immediate stop to Championship Races, RED smoke flares can be used.
<b>WHITE with RED DIAGONAL CROSS</b>	<b>CAUTION: HAZARD ON COURSE</b> – This is a warning of a hazard on the course that does not warrant immediate stopping of the race.

904.20 **LIGHTS** - Lights of the appropriate colours can be used in addition to flags, Green being substituted for Black.

904.30 **NUMBERS** - When numbers are displayed to denote elapsed minutes, they must be displayed in the following sequence:

- No. 1 showing one (1) minute has elapsed
- No. 2 showing two (2) minutes have elapsed.

904.40 All flags must be a minimum size of 1 metre x 1 metre so that Drivers can easily identify the flags.

904.41 All course boats must, as a minimum, be equipped with a red flag and a Caution flag. It is recommended that all course boats all be equipped with a yellow flag, chequered flag and black flag.

## 905 **START**

905.01 The Start of all Championships is to be recorded on video, polaroid or digital camera.

905.011 The results are to be available for viewing by Officials and Competitors if requested.

905.012 Cameras recording the Start are to be positioned on the line of the start and directed towards the start buoy, and must show the clock face, if a clock start is being used.

905.02 In the event of failure of the photographic equipment, the Officer of the Day's decision will prevail.

905.03 Any Boat crossing the start line in the direction of the Race before the fall of the flag will be automatically disqualified from the Race (whether Heat or Final).

905.031 The bow of the Boat is to be taken as its position.

905.04 A Boat that fails to cross the starting line within one (1) minute of the Start will be disqualified from the Race (whether Heat or Final).

905.041 The time of starting in such an instance is when the bow of the leading Boat crosses the start line.

905.042 Marathon-style Races are exempt from this rule.

**905.05 Dead Engine Start Races** - a Boat starting early (0-5 sec's. before the fall of the flag or displaying the light) will be penalised one (1) lap.

- 905.051 A Boat starting more than five (5) seconds early will be disqualified from the Race (whether Heat or Final).
- 905.06 In all Championships, except where run under Rule 901.11, a boat that fails to start in a Heat, or fails to complete the course, is eligible to start in any subsequent heat.
- 905.07 No milling around is permitted within sixty (60) metres of the starting line.
- 905.08 Drivers must cross the starting line in their lane positions.
- 905.081 Breaches of this Rule may lead to disqualification.
- 905.09 Any Boat that enters a Race and joins from the rear of the field at a speed much greater than the speed of the start boat at a flag fall, giving it a speed advantage, will be deemed to have charged the start and be penalised one lap.

## 906 RACE

- 906.01 Australasian and Australian Championships are to be run in two (2) Heats.
- 906.011 Where there are too many starters the Race will be conducted in accordance with Rule 901.11
- 906.012 Unless otherwise agreed, a break of not less than sixty (60) minutes must fall between the finish and start of consecutive Heats. The finish is taken to be when the last competing Boat is removed from the water. For Races conducted under Rule 901.11 the break of at least sixty-minute will be between the finish of the last Heat and the start of the Final
- 906.02 State Championships may, at the discretion of the respective Council, be run in one Heat.
- 906.03 A Boat/Driver responsible for causing a Race to be stopped, along with any Boat disqualified for any rule infringement before the stopping of the Race, will not be permitted to start in the re-run of that Race.
- 906.04 The Race will be declared as the first Boat crosses the finishing line and places calculated as each subsequent Boat crosses the finishing line.
- 906.041 The time of finish of each Boat is to be taken when the Boats bow crosses the line.
- 906.05 If a Race is stopped after two (2) laps of a three (3) lap Race or three (3) laps of a four (4) lap Race, the Race is to be declared on the positions at the completed lap preceding the stoppage.
- 906.06 The time of running of an Australasian, Australian or State Championship of four (4) or less laps on the Championship course is to be limited to six (6) minutes per Heat.
- 906.07 In the event of a crane being used to launch and retrieve Boats, the Boats will be given the opportunity to be re-launched in the same order.
- 906.08 All Australasian, Australian and State Championships for Hydroplane, Outboard and Open Classes are to be run over four (4) laps of the standard course.
- 906.09 All Australasian, Australian and State Championships for Displacement classes which are to be run over three (3) laps of the Standard Course.

## 907 WINNER

- 907.01 **Inboard, Outboard and Formula Future Sections**
- 907.11 The winner of the Championship will be the Boat with the highest points score determined by the Point Score Table.
- 907.12 In Championships conducted over two (2) Heats, a bonus of two (200) hundred points is to be awarded to all Boats completing both Heats.
- 907.13 In Championships conducted under elimination Heats and a Final as described in Rule 901.11, the points scored are to apply to the Final only.
- 907.14 Should two or more Boats score the same total points; the Championship is to be awarded to the Boat having the least total elapsed time for the two Heats.
- Should a tie still exist, the Championship is to be awarded to the Boat having the fastest heat time.
  - Should a tie still exist, the Championship is to be awarded to the Boat having the fastest lap time.

## 908 POINT SCORE TABLE

POSITION	POINTS	POSITION	POINTS	POSITION	POINTS
1 <sup>ST</sup>	400	8 <sup>TH</sup>	53	15 <sup>TH</sup>	7

2 <sup>ND</sup>	300	9 <sup>TH</sup>	40	16 <sup>TH</sup>	5
3 <sup>RD</sup>	225	10 <sup>TH</sup>	30	17 <sup>TH</sup>	4
4 <sup>TH</sup>	169	11 <sup>TH</sup>	22	18 <sup>TH</sup>	3
5 <sup>TH</sup>	127	12 <sup>TH</sup>	17	19 <sup>TH</sup>	2
6 <sup>TH</sup>	95	13 <sup>TH</sup>	13	20 <sup>TH</sup>	1
7 <sup>TH</sup>	71	14 <sup>TH</sup>	9		

## 909 HANDICAP RULES –

These rules can be applied to Formula Future and Handicap Championships. It is recommended that these rules also be used for Interclub Events.

- 909.01 Except when held for specific Classes, Handicap Races are unlimited and open.
- 909.02 The basis for the handicap is to be by timing of trial laps.
- 909.03 Handicaps for individual Races can be adjusted.
- 909.10 Start times are taken as the time given, not the actual start time.
- 909.11 Boats starting before time are disqualified and eliminated from the results of the Race.
- 909.12 Where two Boats are on the same or approximate start time, the handicapper will advise start positions.
- 909.20 Boats may finish up to 2 seconds before their handicap time without a penalty, other than having their times adjusted for the next Race.
- 909.21 The winner of the event is the Boat finishing closest to but not more than 2 seconds before their handicap time.
- 909.22 Places are in order of finishing.
- 909.23 Boats finishing more than 2 seconds before their handicap time are relegated to the next available place after other legitimate finishers. In case of more than one Boat breaking time, places are in order of closest to their handicap time.

## 910 RULES for CHAMPIONSHIPS CONDUCTED as a SERIES

- 910.01 Championships conducted over a number of Races during different Events are to be known as a Series.
- 910.02 The Series will comprise a number of Rounds (i.e.. Events).
- 910.03 Each Round will comprise a number of Heats.
- 910.10 ENTRIES**
- 910.11 There must be four (4) bona-fide entries received 13 days before the advertised date of the first Round of the Series.
- 910.111 *If entries are not received as per rule 910.11 then that championship class shall be eligible to be reallocated with the consent of the original allocated host council not less than 30 days after the original allocated date.*
- 910.12 Additional entries can be accepted provided they are received 13 days before the date of the next Round of the Series.
- 910.13 All Series entries must be forwarded to the Secretary of the Council that has been delegated as overseeing the Series.
- 910.14 No entry fee is payable. However, entrants may be required to pay any fee required by the host Club or each Round, if applicable.
- 910.15 Late Entries will be permitted. Any fees are payable to The Association.
- 910.16 Incomplete or improperly lodged entry forms will be considered invalid.
- 910.20 GENERAL**
- 910.21 The number of Rounds over which a Championship will be conducted is to be nominated at the time of application by the overseeing Council.
- 910.22 The number of Heats conducted at each Round is to be two (2), as per Group 906 Rules.
- 910.30 COURSE**
- 910.31 As per Group 600 Rules.
- 910.40 START**
- 910.41 The method of determining lane position and the Start Line position for each Heat is to be at the conducting Club's discretion in consultation with the overseeing Council or Referee.

- 910.50 RACE**  
910.51 As per Group 906 Rules.
- 910.60 ALLOCATION OF POINTS**  
910.61 Points are to be allocated for each Heat in accordance with the Points Score Table.  
910.62 If Elimination Heats are conducted as per Rule 901.11, points for the Round are to be the total from the Heat and the Final.  
910.63 In the event of a Round being cancelled on the day of the Round and before the running of the first Heat, all attending Boats are to be awarded one half of the maximum first place points, provided that those Boats have passed Scrutineering.  
910.631 Register Class Boats - Scrutineering is to include validity of engine seals and Certificate.  
910.64 All points will be allocated within 60 minutes of the completion of racing.  
910.65 In the event of a Round being abandoned after the running of the first Heat, any Boat which has passed Scrutineering and is able to start in the second Heat will be awarded one half of the first place points for the second Heat.  
910.66 If the Round is being conducted under Rule 901.11, and the Round is abandoned after the first Elimination Heat, Rule 910.63 is to be followed.  
910.67 The lap time along with the total race time will be recorded for each Boat in each Heat of a Series. In the event of tied points, in the Series, the tie will be broken in the following sequence:  
1. The Boat finishing the most number of Heats is the winner.  
2. If a tie still exists and the Boats have finished all Heats, then the winner will be the Boat with the fastest total race times.  
3. If a tie still exists (with the tied Boats having finished all Heats), then the winner will be the Boat with the fastest Heat time.  
4. If a tie still exists (with the tied Boats having finished all Heats), then the winner will be the Boat with the fastest lap time.  
5. In the event of the tied Boats not having finished all, but an equal number of Rounds, the winner will be the Boat with the fastest total race time from the Rounds at which the Boats in question finished the same number of Heats.  
6. If a tie still exists, then the winner will be the Boat with the fastest Heat time from the Rounds at which the Boats in question all finished a Heat.  
7. If a tie still exists, the winner will be the Boat with the fastest lap time from the Rounds in (6) above.  
8. If a tie still exists, there will be joint winners.  
910.68 200 Points will be allocated for each Boat that has passed Scrutineering at each Round.  
910.69 In a five Round Series, Boats will drop points from one Round. In a six Round Series, Boats will drop points from two Rounds. Only the racing points will be dropped.
- 910.70 ENGINE MEASURING**  
910.71 Engines only need to be measured once during Series.  
910.72 Random engine measuring can take place during the Series.  
910.73 Competitors caught cheating during a Series may have a ban of two-years imposed upon them.

# GROUP 1000 – REINFORCED COCKPIT RULES

## 1000 REINFORCED COCKPITS

### 1001 GENERAL CONDITIONS

### 1002 REINFORCED COCKPITS – for Inboard and Outboard Sections

### 1004 REINFORCED COCKPIT ORIENTATION

## 1000 REINFORCED COCKPITS

**FOREWORD:** These rules provide only a minimum standard for Reinforced Cockpits. It is important that constructors continually develop Reinforced Cockpits beyond these minimums and produce Reinforced Cockpits that exceed these standards.

## 1001 GENERAL INFORMATION

- 1001.01 **For Outboard Sections** – All sponsored Boats with engines exceeding 800cc capacity must be fitted with a Reinforced Cockpit approved by The Association.  
All Outboard Mono and Mod VP Boats fitted with engines exceeding 2100cc capacity and fitted with a quickfoot style gearbox must be fitted with a Reinforced Cockpit approved by The Association.
- 1001.02 **For Inboard Sections** - All Boats fitted with a forced induction engine must be fitted must be fitted with a Reinforced Cockpit approved by The Association.  
With the exception of Boats competing in the Pro Stock Class or similar restricted Classes, all sponsored Boats including KT Tunnel Boats with engines exceeding 4,301cc capacity and all sponsored Boats constructed after 1 October 2000 must be fitted with a Reinforced Cockpit approved by The Association.  
With the exception of Boats competing in the Pro Stock Class or similar restricted Classes, all Displacement Boats with engines exceeding 5201cc capacity must be fitted with a Reinforced Cockpit approved by The Association.
- 1001.03 A Reinforced Cockpit is defined as a containment area for Driver and Riding Crew, as approved by The Association, constructed and fitted to a Boat in accordance with the Rules in order to provide protection to the Driver and Riding Crew.
- 1001.04 The Driver and Riding Crew must be seated, and the Reinforced Cockpit must have a restraint system.
- 1001.05 The various components that constitute the Reinforced Cockpit must be properly maintained to ensure reliable operation of all components with emphasis being placed on any canopy release mechanism and restraint system.
- 1001.06 The Driver and Riding Crew of any Boat fitted with a Reinforced Cockpit must ensure that before the Boat enters the water at any Event, or official practice session, that such equipment is inspected by the divers for familiarisation with the Reinforced Cockpit, release systems, and other pertinent matters.
- 1001.07 Any Reinforced Cockpit fitted to a Boat which is entered in a Class other than the Class the Reinforced Cockpit or Boat was first designed for must be upgraded to comply with the Class being entered. E.g. F1 Tunnel converted to KT Tunnel.

## 1002 REINFORCED COCKPITS – FOR INBOARD AND OUTBOARD SECTIONS

- 1002.01 **MANUFACTURE** – For those considering manufacture for the first time, an “Application to Manufacture Form” should be obtained from The Association, completed and returned The Association, along with Test Samples and the prescribed fee, before commencing manufacture.
- 1002.02 Upon successful testing of the samples provided, the Authorised Manufacturer will receive acknowledgement from The Association giving them permission to build Reinforced Cockpits for competition or requesting any further information that may be required.
- 1002.03 The Authorised Manufacturer Registration is to be held by the person successfully completing the application process. The Authorised Manufacturer Registration is not transferable.
- 1002.04 The Authorised Manufacturer of any Reinforced Cockpit will complete a Reinforced Cockpit Notice of Manufacture Form, which is to be lodged with The Association before the Boat fitted with the Reinforced Cockpit is permitted to compete.
- 1002.05 A Reinforced Cockpit Registration Tag must be affixed to the Reinforced Cockpit in such a manner that it cannot be removed.
- 1002.051 The Association reserves the right to remove a Reinforced Cockpit Registration Tag, remove the Boat from the Reinforced Cockpit Register and take disciplinary action upon the Boat Owner and/or Driver of any Boat, found to be guilty of tampering with the Registration Tag.

- 1002.052 If during manufacture of a Reinforced Cockpit, the Authorised Manufacturer for whatever reason ceases to complete the work and subsequent manufacturers are called upon to finish the construction, the Reinforced Cockpit Registration Tag will bear the Registration Number of all Authorised Manufacturers that carried out work on the Reinforced Cockpit, listing the first manufacturer to the last.
- 1002.06 The Reinforced Cockpit Registration Tag must contain the Authorised Manufacturer's name, manufacturer's Registration Number, Reinforced Cockpit manufacturer number, Newton rating, engine capacity limit and the date of manufacture.
- 1002.07 No Boat fitted with a Reinforced Cockpit will be permitted to compete at any Event without a Reinforced Cockpit Registration Tag.
- 1002.08 Imported Reinforced Cockpits are to be referred to The Association along with the overseas manufacturer's details, material specification and core shear strength details for registration, before the Boat fitted with the Reinforced Cockpit is permitted to compete.
- 1002.081 Purchasers of overseas Reinforced Cockpit should ensure that the above information is available before purchase.
- 1002.082 The Association will issue a Reinforced Cockpit Registration Tag once this information is received. A fee as set by The Association will be charged.
- 1002.09 Any Boat fitted with a Reinforced Cockpit not manufactured by an Authorised Manufacturer or an imported cockpit not approved by The Association will not be permitted to compete at any Event.
- 1002.010 Reinforced Cockpits manufactured after 31st August 2005 must pass the standard tensile test as outlined in Rules 1002.30 through to 1002.44
- 1002.011 Reinforced Cockpits manufactured before 31 August 2005 (1000/2000 Newtons) and removed from the original Boat with the intention to install into another Boat must be upgraded to meet the current Rules and Newton rating as listed in the current Rule Book.
- 1002.012 Any required upgrade to the Reinforced Cockpit must be carried out by an Authorised Manufacturer.
- 1002.013 At the completion of the upgrade, the Authorised Manufacturer will affix an additional (2<sup>nd</sup>) Registration Tag indicating the following:
- Authorised Manufacturers Name
  - Authorised Manufacturers Number
  - Date of Upgrade
  - Newton Rating
- 1002.10 DESIGN** - For Reinforced Cockpits constructed before November 2000 outside Australia, detailed drawings (as required by Rule 1002.20) that reflect the design and construction of the Reinforced Cockpit must be prepared by the Boat Owner and submitted to The Association for inspection of the Boat and Reinforced Cockpit.
- 1002.11 The Aft panel (bulkhead) above the deckline of any Reinforced Cockpit built after August 2014 must be of a convex shape in the both the vertical and horizontal planes. The minimum acceptable curve in the plan view shall be 100mm. The curve shall be measured by ruling a straight line from corner to corner of the aft panel at the deckline and the curve must project at least 100mm aft of this line. The curvature in the vertical plane must also be a minimum of 100mm. The aft most point of the panel must not be above the deckline in any particular Boat. This part of the reinforced Cockpit may be an add-on panel but it must be constructed of the same materials as the test panels supplied to The Association and laminated, glued or bolted into the Reinforced Cockpit at the time of constructions if the Manufacturer does not wish to alter the mould. Any bolts passing through this panel must be hard spotted for location of seats, seat belts or lifting eyes, i.e. the coring must be removed at least bigger than the corresponding fender washer of the bolt and replaced with a material that cannot be crushed when the bolts/nuts are tightened.
- 1002.20 DRAWING AND VERIFICATION** - Three view drawings (plan, side and elevation) of the design of the Reinforced Cockpit, the bulkheads, the type of canopy, the buoyancy system and the restraint system anchorage points must be lodged with The Association before construction of the Boat and/or Reinforced Cockpit.
- 1002.21 **Restraint Anchor Points** – Drawings in three dimensions showing restraint anchor points are to be supplied with material specification requirements (Rule 1002.170).
- 1002.22 **Canopy and Release Method** – Drawings must be provided showing the canopy aperture dimensions for a full or partial canopy.
- 1002.23 Drawings must show the material specification of the transparent areas. These drawings must be submitted to The Association with all technical information, allowing The Association to make an informed decision as to approval.
- 1002.24 Glass is not permitted.
- 1002.25 Drawings must show the method of construction of release devices for totally enclosed canopies.

- 1002.30 MATERIAL SPECIFICATION**
- 1002.31 Any Reinforced Cockpit constructed after 31<sup>st</sup> August 2005 must meet the following requirements:  
**TENSILE TEST (ASTM D638):** Should equal that of 0.020" 2024 T361 Aluminium alloy (Ultimate Tensile Strength of 68k PSI) this is equivalent to 3000 Newton meters (680 lbs) breaking load on 0.5" width sample.  
**CORE DENSITY:** The core must be a minimum of 100kg/cubic metre density.
- 1002.32 **MINIMUM SKIN THICKNESS:**  
 Inboard Displacement, Inboard Hydroplane, Inboard Tunnel and Outboards up to and including 1500cc: should be a minimum of 0.035" skin thickness and a minimum core thickness of 10mm.  
 Inboard Displacement, Inboard Hydroplane, Inboard Tunnel and Outboards over 1500cc and up to and including 4999cc: should be a minimum of 0.050" skin thickness and a minimum core thickness of 12mm.  
 Inboard Displacement, Inboard Hydroplane and Inboard Tunnel over 5,000cc: should be a minimum of 0.070" skin thickness and a minimum core thickness of 20mm.  
**Inboard Displacement, Inboard Hydroplane and Inboard Tunnel with forced induction: should be a minimum of 0.070" skin thickness and a minimum core thickness of 20mm.**
- 1002.33 The following ratings are to be applied to all new Reinforced Cockpits:  
**OUTBOARD CLASSES**  
 Up to 1500cc 2000 Newtons  
 1501cc and above 3000 Newtons  
**INBOARD CLASSES**  
 Up to 1500cc 2000 Newtons  
 1501 to 4999cc 3000 Newtons  
 5000cc and above 5000 Newtons above deck, 3000 Newtons below deck
- 1002.34 All Inboard Displacement Capsules manufactured after September 2015 shall have an integral floor separate to the bottom of the boat, or if the bottom of the boat is used as the floor it must meet as a minimum the 3000 Newton rating and the side, front and rear bulkheads are to be laminated to the floor or bearers as required to seal the base area of the cockpit from the ingress of fluids etc.
- 1002.40 MATERIAL SAMPLE TESTING**
- 1002.41 SAMPLE CONSTRUCTION REQUIREMENTS**
- 1002.411 Sample quantity must be three (3) samples including a sample of the jointing/bonding of the cockpit halves, transverse to the length and in the middle of the sample.
- 1002.412 Trimmed sample size must be 100mm wide (+/- 1.0mm) x 800mm long (+/- 5mm) with the width being parallel.
- 1002.413 For fibre orientation, the 800mm length must be parallel with the bottom surface of the cockpit.
- 1002.414 Samples must be laminated on a flat surface using the same manufacturing process, materials and fibre orientations as re intended for cockpit manufacture.
- 1002.415 The samples must have uniform thickness with no core crushing along any edge.
- 1002.416 The samples must have one moulded face and the other being unmoulded. The moulded face will be taken as the external surface of the cockpit during testing.
- 1002.417 The samples must be representative of the thinnest layup of the cockpit.
- 1002.418 The samples and reinforced cockpit must be manufactured using balance or unbiased materials.
- 1002.42 SAMPLE TEST METHOD – LONG BEAM FLEXURE STRENGTH TEST**
- 1002.421 The sample will be supported across its full width perpendicular to the 800mm edge by two (2) parallel 25mm dia. steel bars at a distance of 500mm apart. The load will be applied equally through two (2) 25mm dia. steel bars at a distance of 167mm parallel from each support.
- 1002.422 The moulded face of the sample will have the load applied and the unmoulded face will support the sample.
- 1002.423 The load will be applied at 0.4mm/sec and the deflection will be measured at the two (2) 25mm dia. steel bars applying the load within two (2) minutes.
- 1002.43 SAMPLE TEST REQUIREMENTS**
- 1002.431 The sample when loaded with a force of either 2000, 3000 or 5000 Newton must have no more than a maximum deflection of 25mm without the sample failing.
- 1002.432 The sample weight in gram/m<sup>2</sup> will be calculated: skin thickness and sample thickness will be measured to enable inspection and comparison of damaged cockpits.
- 1002.433 Further non-destructive test analysis methods may be used to compare test samples with homologated cockpits during the life of each cockpit.
- 1002.44 SAMPLE MANUFACTURING INFORMATION REQUIREMENTS**
- 1002.441 Ply laminating sequence stating which ply is the moulded face.
- 1002.442 Ply materials.

- 1002.443 Ply weave styles.
- 1002.444 Ply material weight in gram/m<sup>2</sup> (dry weight i.e.. without resin).
- 1002.445 Ply orientation (where 0° is parallel with the 800mm edges).
- 1002.446 Core material and density in lbs/ft<sup>3</sup> or kg/m<sup>3</sup>
- 1002.447 Manufacturing method (stating vacuum, pressure and temperature).
- 1002.448 A 100mm x 100mm sample of all materials used (resin samples not required).
- 1002.45** All costs associated with Material Sample testing will be borne by the respective Reinforced Cockpit Manufacturer.
- 1002.46** Applications, samples and payment are to be sent to The Secretary (APBA National Council).

**1002.50 ACCIDENT REPAIR and REPORTING**

- 1002.51 Any Reinforced Cockpit involved in or sustaining damage in an accident or incident must be referred to The Association via the Incident Report form.
- 1002.52 If damaged, repairs are to be made by an Authorised Manufacturer in consultation with the original manufacturer.
- 1002.53 On completion of the repairs, notification must be sent to The Association.
- 1002.54 The same procedures of reporting will also be required for and modifications or alterations carried out to a Reinforced Cockpit.
- 1002.55 For any repairs, modifications or alterations to a Reinforced Cockpit carried out outside Australia, notification must be sent to The Association by the Boat Owner, detailing the extent of the work and the name and contact details of the repairer. Upon return to Australia, an APBA Official will inspect the Boat and Reinforced Cockpit prior to the Boat being permitted to compete.

**1002.60 COCKPIT CANOPY**

- 1002.61 **CANOPY DESIGN** – Reinforced Cockpits may be fitted with a canopy which must be constructed of materials of sufficient strength to provide protection. The lay up must be equal to the minimum lay up for that Class, with attention to be paid to the strength of all edges.
- 1002.62** For Reinforced Cockpits manufactured after 31st August 2005 - The hatch, if fitted, must have a flange to ensure that the lid cannot collapse into the cockpit in the event of an accident.
- 1002.63 **CANOPY APERTURES** – Fixed canopies should have the entry/exit aperture located directly above the Driver's head. The aperture must be unobstructed to facilitate easy exiting.
- 1002.64 The aperture opening should be at least 0.50m in length and 0.40m in width.
- 1002.65 The canopy aperture should be cut with all corners having a radius of 0.025m minimum or 0.25m maximum.
- 1002.66 The radius should be constant and have a smooth finish to relieve stress.
- 1002.67 When a canopy hatch is fitted, it must be constructed so as not to provide any impediment to the exiting of the Driver when fully race fitted.
- 1002.68 On any Reinforced Cockpit fitted with a canopy, provision must be made for the canopy to be opened from both inside and outside
- 1002.69 All windscreens must be made from shatterproof material.

**1002.70 REMOVABLE PINS – For Outboard Sections:** All Outboard Boats with a Reinforced Cockpits fitted with canopies are to have a removable pin in the front hinge.

- 1002.71 This pin is to be made to be removable from inside and outside allowing the canopy to be totally removed in an emergency.
- 1002.72 It is prohibited for any other mechanical link to exist between the canopy and the structure of the hull, which may prohibit the complete removal of the canopy.

**1002.80 HEAD PROTECTION**

- 1002.81 A Minimum of 5cm (2 inch) clearance above Driver's head, with a recommended 10cm – (4 inches), covering at least 50% of the top of the helmet and at least 50% of the side of the Helmet with the Driver's head in the furthest aft position as an integral part of the Reinforced Cockpit construction.

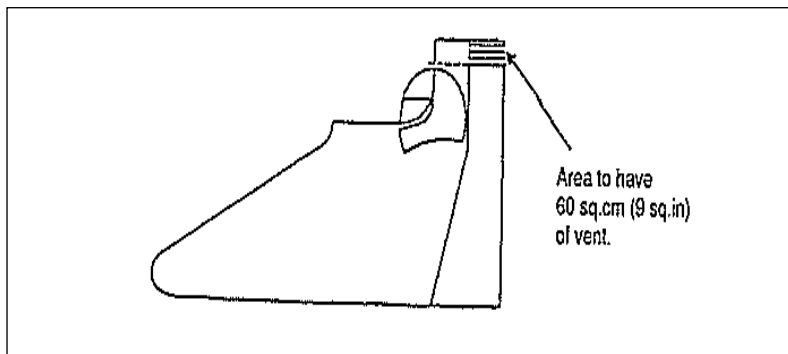

- 1002.82 It is recommended that a minimum 12mm (½ inch) 4kg (9.1 lb) Ethofoam or other energy absorbing foam support completely around inside of helmet area to prevent injury from helmet hitting any part of the Reinforced Cockpit.



1002.85 It is recommended that in an open Reinforced Cockpit opening(s) totalling 60 cm<sup>2</sup> (9 sq. inches) surrounding the Driver's head be added, to relieve the hydraulic affect.

**1002.90 BODY PROTECTION**

1002.91 It is recommended that energy absorbing foam padding to be strategically placed inside the Reinforced Cockpit in areas the knees, hands, etc, might impact.

1002.92 No sharp edges or protrusions anywhere inside or around the entryway of the Reinforced Cockpit.

**1002.100 VISIBILITY**

1002.101 The Driver must have clear and safe, undisturbed visibility whilst racing.

1002.102 The visibility of the Driver must be through a horizontal arc of **180 degrees (90 degrees either side of the centre line of the Boat)**.

1002.103 For Reinforced Cockpits without canopies - the top of the front of the Reinforced Cockpit will be a maximum of 12.5cm (6 inches) below eye level and so constructed as to deflect water away from the Driver.

**1002.110 MIRRORS**

1002.111 Left and Right Rear view mirrors are mandatory and are to be effectively securely fitted on all Boats fitted with a Reinforced Cockpit.

**1002.120 FLOTATION/BUOYANCY**

1002.121 It is recommended that enough buoyancy is provided in the Boat to ensure that the Boat floats if capsized or holed.

1002.122 This buoyancy should be provided in at least 4 separate flotation units.

1002.123 All Boats must have enough buoyancy deemed adequate by the Boat Owner and Driver to float the Boat in a swamped state

**1002.130 AIR VENTS – For Inboard and Outboard Sections**

1002.131 Air vents must be added to bow of:

- 2 x 20 square cm (3 square inches) unrestricted area vents on pickle fork tunnel boats
- 1 x 40 square cm (6 square inch) of unrestricted area on a mono hull

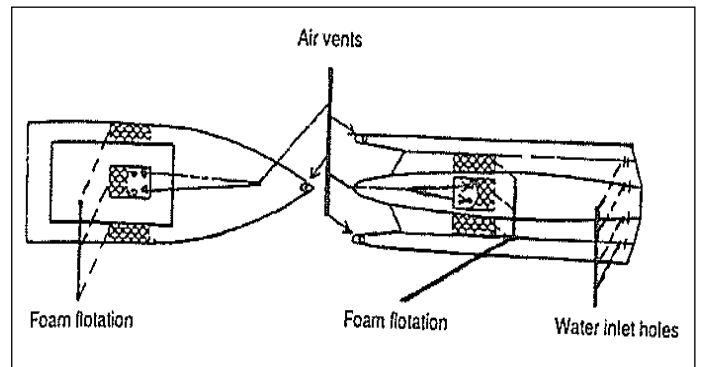

*Recommended Foam Flotation & Air Vent Locations*

1002.132 The Water inlet holes must be as shown in Diagram 2.

1002.1321 The water inlet holes must be at least 40cm<sup>2</sup> in area each side and communication with the air space inside the sponsons.

1002.1322 Any communicating holes in intervening bulkheads must be the same size.

1002.1323 Air/Water must be able to pass freely from these holes to the air vents the upper front of the sponsons.

**1002.140 STEERING WHEEL**

1002.141 A removable, spring-loaded steering wheel is required.

1002.142 The steering wheel must be easily removable without tools, using only one hand.

**1002.150 DEFORMABLE PICKLES – For Outboard Hydroplane Classes**

1002.151 All sponsoned Boats fitted with a Reinforced Cockpit and with engines exceeding 800cc capacity are to have deformable pickle forks fitted (as listed in the current UIM Rule Book – see diagram below).

1002.152 The most forward end of the pickle fork must be deformable and must be designed to crush.

1002.153 Mod VP hulls are exempt from this rule.

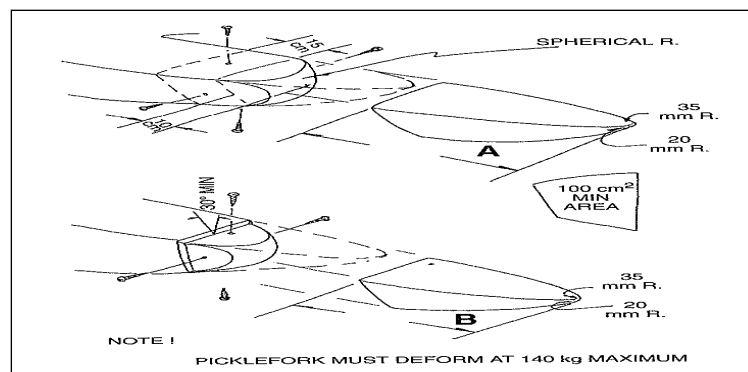

**1002.160**

**ENGINE SHUT OFF**

1002.161

Boats fitted with a Reinforced Cockpit must have an Engine Shut Off button or switch located within the Reinforced Cockpit immediately accessible to the Driver.

1002.162

Externally, an Engine Shut Off switch, which should shut down any electric fuel system, must be fitted to the left-hand (port) outside of the Boat, either on or immediately behind the Reinforced Cockpit.

1002.1621

External switches will be clearly marked - ENGINE SHUT OFF SWITCH.

1002.1623

Kill switch lanyard connections are not required on Boats fitted with a Reinforced Cockpit.

**1002.170**

**RESTRAINT SYSTEM AND BELTS (see Diagram)**

1002.171

Any Driver or riding Crew competing in a Reinforced Cockpit must be restrained by an approved restraint system as used in motor racing, consisting of a minimum 5-strap/5point mounting design.

1002.172

Strap location will be minimum two hip, one crotch, and two shoulder all hooked together in a central release system.

1002.173

This release mechanism must remain released/open once it is activated and until it is reset.

1002.174

It is recommended to use the lever-latch release system.

1002.175

Belting must be a minimum of 5cm (2") in width and of an approved design.

1002.176

The attachment points of the restraint system must consist of a minimum of 5/16" grade 5 or 8mm grade 8.8 stainless steel and 3mm stainless steel or 6mm aluminium plate of 100sq cm per attachment point.

1002.177

The plate should be glued to the Reinforced Cockpit.

1002.178

Metal backing plates are not required if the harness is bolted to a roll cage.

1002.179

If a Boat fitted with a Reinforced Cockpit is involved in a serious incident the belts of the restraining system must be removed and replaced with new belts.

All restraining belts must be replaced every five (5) years. All restraining belts must be replaced immediately if found to be frayed or damaged.

The start date of use of restraining belts shall be no earlier that September 2014, at which time, during the Technical Inspection, the restraining belts shall be marked with a date.

**1002.180**

**AIR SYSTEM**

1002.181

**All Drivers must have an on-board air supply (SCUBA) available as either "Spare Air" or air which is supplied continuously to the driver.**

1002.182

The air supply bottle can be carried on the Driver and/or securely mounted to the Boat.

1002.183

It is the responsibility of the Driver to have a fully charged, in test air bottle at all times with a minimum capacity of 6 cu ft (30cu ft is recommended in displacement boats). Please note: According to Australian Standards all Scuba cylinders must be hydrostatically tested annually.

1002.184

The regulator must work in any position.

1002.185

It is recommended that Drivers of Boats fitted with a Reinforced Cockpit complete appropriate SCUBA training as offered by professional diving instructors or organisations.

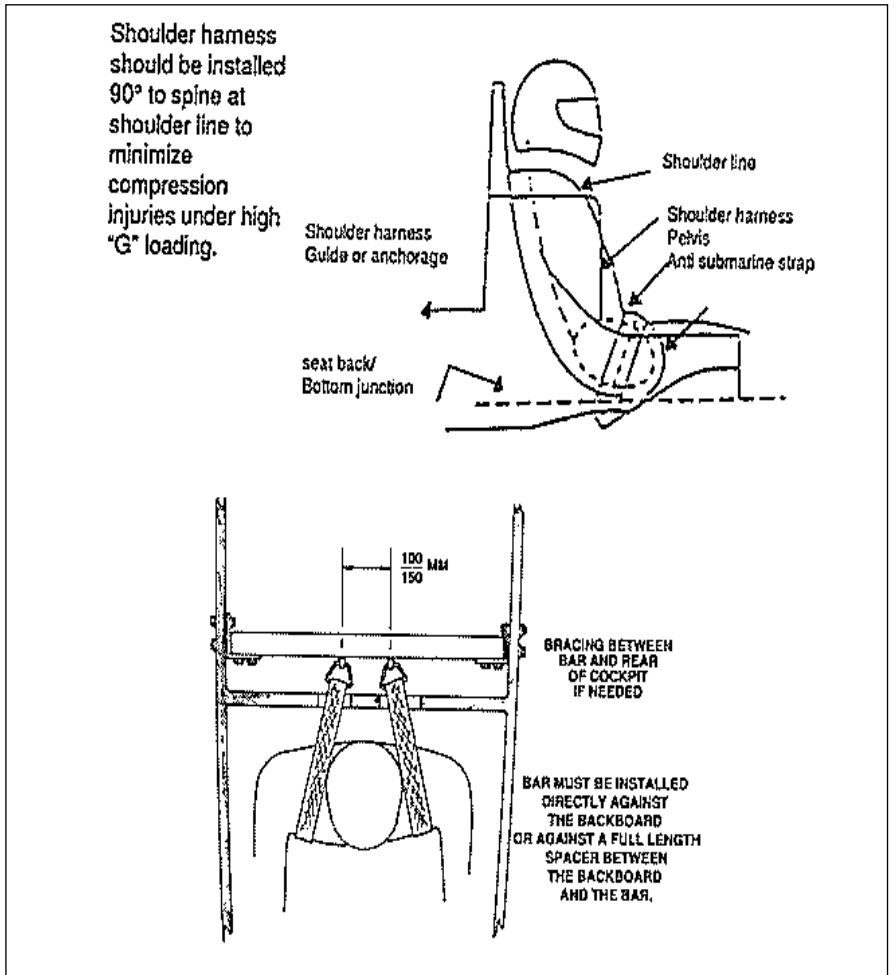

- 1002.186 If a detachable fittings system is used then Parker series 60 fittings are to be used on the Driver's detachable air line with the female fitting on the Driver's mask hose, Parker stainless steel part no. SH1-62 or brass no. BH1-60 60 and Parker stainless steel part no. SH1-63 or brass no. BH1-61 on the line from the air bottle regulator.
- 1002.187 It is recommended that the Drivers mask air line be a maximum of 600mm to the detachable fitting and the line from the air bottle regulator to the detachable fitting, to be of sufficient length to allow the Driver to be clear of the boat.

### **1003 REINFORCED COCKPIT ORIENTATION**

- 1003.00 All Drivers and Riding Crew competing in Boats fitted with a Reinforced Cockpit complete a Reinforced Cockpit Orientation every year in a format approved by The Association.
- 1003.01 The Association strongly recommends that all rescue personnel also attend the Reinforced Cockpit Orientation.
- 1003.011 All Reinforced Cockpit Orientations must be conducted in clear water so that divers assisting with the orientations have unobstructed visibility to assist the participants.
- 1003.02 Any Driver or Riding Crew that has not completed a Reinforced Cockpit Orientation can be provided with an exemption in a sanctioned practice session on their own. The Driver or Riding Crew, although permitted to practice, will not be permitted to race in a Reinforced Cockpit under any circumstances.
- 1003.03 The purpose of the Reinforced Cockpit Orientation is to acquaint the Driver with a situation where they are immersed in water as a result of an accident and to give an opportunity to practice evacuating an immersed Reinforced Cockpit and ensure that their mask/device is properly adjusted and they are proficient with the use of it.
- 1003.04 The test rig should simulate a Reinforced Cockpit as closely as possible. Turning the test rig over must be possible so that the Driver, strapped inside, is totally immersed in water.  
The test rig must have the following:
- An opening no larger than that found in a normal Reinforced Cockpit, with the cockpit sides no lower than the drivers shoulders.
  - A restraint system as described in Rule Section 1002.170.
  - A detachable steering wheel as described in Rule Section 1002.140.
- 1003.05 **PERSONAL EQUIPMENT/APPAREL** – the Driver must wear the following personal equipment/apparel, of which all must be their own and that which they will be using in their Reinforced Cockpit. (No borrowed Equipment):
- Driving Suit
  - Shoes
  - Gloves (if normally used by the driver)
  - Helmet
  - PFD
  - Helmet Restraint
  - Air Mask/Device
  - The Driver must also present their Rule Book on the day to have their participation recorded.
- 1003.06 The organisers of the Reinforced Cockpit Orientation must ensure that the persons assisting are capable of extricating the Driver rapidly in case the Driver is unable to do so.
- 1003.061 There must be a person qualified in resuscitation present during the Reinforced Cockpit Orientation.
- 1003.062 The organisers must explain each sequence of the Reinforced Cockpit Orientation to the participants beforehand.
- 1003.07 **PERFORMING THE REINFORCED COCKPIT ORIENTATION**  
The organisers will perform the Reinforced Cockpit Orientation according to the following sequence or as modified after discussion with the participant to suit their ability. If they believe they are suitably prepared, then Steps 1 to 3 may be by-passed however 4 rollovers must be completed as per steps 4 and 5 below.
1. Complete rollover with steering wheel detached, Driver restraint system unsecured and without PFD or Helmet.
  2. Complete rollover as 1, but with steering wheel attached.
  3. Complete rollover as 2, but with Driver wearing all safety equipment.
  4. Complete rollover as 3, but with Driver restraint system secured.
  5. Complete rollover as 4, but in a darkened environment or using dark goggles.
- Drivers experienced in Reinforced Cockpits, when being retested, only need to complete a total of 2 rollovers wearing all safety equipment and are to complete sequences 4 and 5 as above.

- 1003.071 All Drivers that use an on-board air supply are to be orientated with retrieval and operation of the regulator whilst upside down in the water in the test rig.  
NOTE: All the Orientation steps using an air supply, the driver must demonstrate his ability to use the air system successfully under water for approximately 30 seconds in simulated accident conditions, meaning that the driver shall not move until the diver has indicated by a tap on the cockpit that they may start their escape procedure.  
Drivers to remember this order:  
AIR --LID --WHEEL (if required) -BELT-OUT-WAIT.
- 1003.072 All Drivers that have to use such equipment are highly recommended to seek professional training by a recognised body i.e. PADI, BSAC, SAA who will provide training on how to assemble and use the equipment and they may advise you of a training schedule for the use of your equipment.  
The APBA is not responsible for instructing you on the correct use of your Air Supply Equipment.
- 1003.08 PERFORMANCE EVALUATION – The organisers and participants should feel that the orientation was completed satisfactorily and that a feeling of confidence has been achieved by the participants.

# GROUP 1100 – INBOARD SECTION RULES

## 1101 GENERAL INFORMATION

### 1102 HULLS

### 1103 ENGINES

### 1104 FUEL

### 1105 SPECIFIC CLASS RULES

- Unlimited Displacement
- Racing Runabout
- Oz Lites 1.6 Litre Boating Register
- 4.2 Litre Stock Register Classes
- Carburettored Cast Iron Displacement
- Pro Stock
- Grand Prix Hydroplane
- Blown Lites
- Superstock Restricted

## 1101

### GENERAL

#### 1101.01

#### CHAMPIONSHIP CLASSES and TROPHIES

The Association will control the following Australasian and Australian Championships and Special Events.

#### AUSTRALASIAN CHAMPIONSHIPS

Unlimited Open	E C Griffith Cup
Unlimited Hydroplane	A E Baker Trophy
Unlimited Displacement	Marjorie Watson Trophy

#### AUSTRALIAN CHAMPIONSHIPS

Unlimited Open Inboard and Outboard	Stannard Cup
Unlimited Open Inboard	Hayes Wood Trophy
Unlimited Hydroplane	Max Kirwin Trophy
Unlimited Displacement	Errol Jay Trophy
Unlimited Unblown Displacement	Australian Dulux Trophy
Grand Prix (GP) Hydroplane	Mary and Ernie Nunn Trophy
Blown Lite Displacement	<i>Trophy to be allocated</i>
Superstock Restricted Class	NSW State Council Trophy
6000cc Hydroplane	Lawson Shield
6000cc Naturally Aspirated Displacement	Albert Corn Trophy
6000cc Carburettored Cast Iron Displacement	Griffith Boat Club Trophy
<i>(formerly 6000cc Restricted Displacement)</i> Pro Stock	Keith Swift Cup
5200cc Naturally Aspirated Displacement	Motor Spares Trophy
5200cc Carburettored Cast Iron Displacement	Wyangan Cup
Forced Induction Displacement	<i>Trophy to be allocated</i>
4.2 Litre Stock Hydroplane	Replacement Trophy
4.2 Litre Stock Displacement	A S D A Trophy
Oz Lites 1.6 Litre Restricted Motor	Col Brown Trophy

## SPECIAL AUSTRALIAN EVENT

<b>Unlimited Auto Engine Inboard and Unlimited Open Outboard</b>
--

<b>Riverside Trophy</b>
-------------------------

- 1101.02 The Classes for Championships, Speed and Time Trials, and Special Record Attempts for the ensuing season are to be ratified annually by The Association.
- 1101.03 The Stannard Cup Race must be conducted in accordance with the regulations as set out in the Deed of Gift governing the Race.
- 1101.04 The Riverside Trophy Race must be conducted in accordance with the regulations as set out in the Deed of Gift governing the Race.
- 1101.05 Drivers and Boats stepping up from their own Class into a larger capacity Class must meet the minimum requirements (hull, ages, etc) for the Class being entered.

## 1102 BOATS – GENERAL INFORMATION

### 1102.00 GENERAL

- 1102.01 **Reinforced Cockpits** - All Boats fitted with a forced induction engine must be fitted with a Reinforced Cockpit approved by The Association.

With the exception of Boats competing in the Pro Stock Class or similar restricted Classes, all sponsored Boats including KT Tunnel Boats with engines exceeding 4,301cc capacity and all sponsored Boats constructed after 1 October 2000 must be fitted with a Reinforced Cockpit approved by The Association.

With the exception of Boats competing in the Pro Stock Class or similar restricted Classes, all Displacement Boats with engines exceeding 5201cc capacity must be fitted with a Reinforced Cockpit approved by The Association.

- 1102.02 The length of the Boat must not be more than 9.144 metres.
- 1102.03 The length must be measured between perpendiculars at the extreme bow and stern of the Boat.
- 1102.04 With the exception of Boats powered by standard-production forced induction engines of less than 3,700cc capacity, Boats powered by forced-induction (supercharged or turbocharged) engines must be of a minimum length of 5.5 metres.
- 1102.05 Any extending parts such as rubbing strakes, fenders, stabilising or trim tabs, rudder, skeg or cavitation plate are not to be included in the length measurement.
- 1102.06 The propelling unit must be driven by an internal combustion engine or engines, which must be mounted inboard.
- 1102.07 All propelling forces must be directed in and against the water.
- 1102.08 Any Boat fitted with a stern drive (inboard/outboard leg) and using power trim must have a working trim indicator fitted in a position clearly visible to the Driver at all times.
- 1102.09 Hydrofoils are not permitted on any Class of Boat.
- 1102.10 Boats powered by a jet engine or rocket engine are not permitted to race but may enter Speed & Time Trial Events only.
- 1102.11 All inboard Boats must have floatation securely fitted or built in to assist floatation in the event of the hull being swamped or submersed.
- 1102.20 Hydroplane Class Boat** – A Hydroplane hull is one where the immersed portion of the hull is divided into two or more distinct planing surfaces by a transverse or longitudinal (or both) step or steps.
- 1102.201 For Hydroplane Classes with minimum weight restrictions, the minimum weight of the Boat will include the Driver will full race apparel. The only exception to this Rule is the Grand Prix Hydroplane Class. The minimum weight will also include residual fuel but all water must be drained.
- 1102.30 Displacement Class Boat** – The hull must be displacement or monoplane type in which the continuity of the portion of the hull is immersed at rest.
- 1102.301 In racing trim, with the Driver and Riding Crew on board, must not be interrupted longitudinally or transversely by any form of break, step or device of construction or hydrofoil, that would provide multiple planing surfaces except as specially permitted.
- 1102.302 Lap strake or reverse lap strake construction can be used provided the immersed portion of the strakes (planks) is approximately parallel with the centre line of the hull and the depth of the strake (plank) be no greater than 35mm.
- 1102.303 Planing strakes (planks) unless continuing to the tuck (transom) must finish on an angle being not less than 450mm from the point of commencement of the angle to flush with the hull bottom and the angles not to be concave to the hull bottom.
- 1102.304 Non-trip chines with a rise of not less than 75mm in 300mm, vertical sided keels and skid fins will be permitted.
- 1102.305 At the option of the Boat Owner or the builder, that point where the planking meets the non-trip chine can be rounded or left square regardless of the thickness of the planking.

- 1102.306 The term hull will include all additions and attachments below the waterline with the exception of the shaft, strut, propeller, rudder, fin and such that are usual and necessary.
- 1102.307 Cavitation plates, trim tabs and after planes that are fixed or adjustable whilst underway will be permitted.
- 1102.308 The depth (thickness) of the strake (plank) is to be taken by stretching a wire or similar material around the bottom of the hull, at right angles to the centre-line, on the point being measured.
- 1102.309 The depth (thickness) is to be measured at right angles to the hull surface and this depth must not be more than 35mm at any point.

1102.31 **WINGS**

- Only Boats fitted with Reinforced Cockpits and with an engine capacity of 5,000cc and above, **or a Reinforced Cockpit boat with a forced induction engine of any capacity** are permitted to use wings.
- Only single or dual plane wings are permitted.
- The wing is to be mounted to the engine or the engine bearers.
- The wing including the side fins/spill plates should be a maximum of 450mm higher than the highest point of the Boat and must not extend beyond the extremities of the hull.
- The suitability and adequacy of the wing is the responsibility of the Boat Owner, who should be satisfied that it is competently designed, manufactured and fitted so as to remain fixed and operational at high speeds.

1102.32 **GUIDELINES FOR THE USE OF ADJUSTABLE WINGS**

- The Association may grant approval for the trial use of an adjustable wing, provided a detailed diagram is submitted to and is subsequently approved by The Association.
- Such adjustable wings will be approved to be trialed on Unlimited Displacements Class Boats only for a period of 12 months and can be used in APBA Championship events.
- At the end of the trial period and after review by The Association (with input from the Boat Owner and/or Driver), provided the Boat's handling characteristics are safe, permanent approval may be granted.
- The Association will have the final decision and the ability to revoke approval at any time.

**1103 ENGINES – GENERAL INFORMATION**

- 1103.01 No engine oversize is permitted in any Class Championship, Speed or Time Trial, or Special Record Attempt.
- 1103.02 When the engine is a Rotary the nominal cylinder capacity must be multiplied as below:  
Rotaries have engine capacity multiplied by 1.8  
Example:  
13B rotary is 1308cc x 1.8 = 2354.4cc
- 1103.03 Turbine engines when used to power any boat must comply with the current restrictions imposed by the American Power Boat Association.
- 1103.04 5200cc and 6000cc class racing will be limited to naturally aspirated engines. The use of forced induction (supercharged or turbocharged) engines is not permitted.

**1104 FUEL – GENERAL INFORMATION**

- 1104.00 The use of leaded fuels will be permitted until such time as the Federal Government or one of their agencies prohibits the use of leaded fuels.
- 1104.01 The use of Nitrous Oxide or any other chemical supercharging is not permitted in any Class. **Chemical Supercharging shall include the use of Nitro-Methane or any fuel containing MTBE (Methyl Tertiary Butyl Ether) above the Australian Government Department of Environment and Energy standard.**

**1105 UNLIMITED DISPLACEMENT CLASS RULES**

- 1105.01 Any Boat competing in the Unlimited Displacement Class must be fitted with a Reinforced Cockpit.

**1106 RACING RUNABOUT CLASS RULES**

- 1106.01 The Boat must comply with Rule 1102.30 – Displacement Class Hull.
- 1106.02 The length of the Boat must not be less than 4.2 metres, and the beam not less than 1.37 metres.
- 1106.03 Two functional seats must be fitted.

**1107 OZ LITES 1.6 LITRE BOATING REGISTER CLASS RULES**

- 1107.01 The Rules and Regulations of the Oz Lites 1.6 Litre Boating Register are complimentary to the Rules

of The Association.

- 1107.02 All Boats, Drivers and Events must comply with both the regulations of The Association and the Register.
- 1107.03 No Boat will be permitted to start in any 1.6 Litre Event unless its engine has been checked for compliance with the Oz Lites 1.6 Litre Boating Register Class Regulations and sealed beforehand.
- 1107.04 Should an engine repair or rebuild be necessary before an Event and time does not allow for another measure and seal before starting, the engine must then be sealed before competing on the day and then measured in accordance with the current Rules on examining and measuring.
- 1107.05 Where there is a conflict between The Association's Rules and the Register Class Rule, The Association's Rules are to take precedence.
- 1107.06 Rules covering the technical specifications, configuration and measurements of both the hull and engine are the sole responsibility of the Register Members and can only be altered in accordance with the Register Rules.
- 1107.07 Any changes to the Register Rules must be submitted to The Association for endorsement.
- 1107.08 Engines must comply with the regulations of the Register.
- 1107.09 Fuel is limited to petrol based fuels (Pump Fuel) only.

#### **1108 4.2 LITRE STOCK REGISTER CLASS RULES**

- 1108.01 The Rules and Regulations of the 4.2 Litre Stock Displacement Class Register or 4.2 Litre Stock Hydroplane Class Register are complimentary to the Rules of The Association.
- 1108.02 All Boats, Drivers and Events must comply with both the regulations of The Association and the Registers.
- 1108.03 No Boat will be permitted to start in any 4.2 Litre Stock Class Events unless its engine has been checked for compliance with the 4.2 Litre Stock Class Regulations and sealed beforehand.
- 1108.04 Should an engine repair or rebuild be necessary before an Event and time does not allow for another measure and seal before starting, the engine must then be sealed before competing on the day and then measured in accordance with the current Rules on examining and measuring.
- 1108.05 Where there is a conflict between The Association's Rules and the Register Class Rule, The Association's Rules are to take precedence.
- 1108.06 Rules covering the technical specifications, configuration and measurements of both the hull and engine are the sole responsibility of the Register Members and can only be altered in accordance with the Register Rules.
- 1108.07 Any changes to the Register Rules must be submitted to The Association for endorsement.
- 1108.08 Engines must comply with the regulations of the Register.
- 1108.09 Fuel is limited to petrol based fuels (Pump Fuel) only.

#### **1109 CARBURETTED CAST IRON DISPLACEMENT CLASS RULES**

- 1109.01 Hulls must comply with the requirements of Rule 1102.30.
- 1109.02 ENGINE
- The engine block must be cast iron.
  - The engine lubrication systems are free.
  - Head and manifold porting is permitted.
  - The heads must be either cast iron or aluminium with 2 valves per cylinder and push rod operated.
  - The manifolds are to be over the counter production items and must be cast iron or cast alloy.
  - Individual runner manifolds are not permitted on V-engines.
  - Multiple carburetors are limited to a throttle bore diameter of 42.86mm.
  - There are no carburettor restrictions on single carburettor V-engines or in-line/straight engines.
- 1109.03 Commercially available pump fuels including Aviation fuel (Av-gas) are permitted to be used until such as the Federal Government or one of its agencies prohibits the use of, or sale of leaded fuels.
- 1109.04 Performance enhancing additives are not permitted.
- 1109.05 Specifically designed or manufactured racing fuels are not permitted.

#### **1110 PRO STOCK CLASS RULES**

- 1110.01 All Boats must comply with the requirements of Displacement Class Hull Rule 1102.30.
- 1110.02 Stern Drives are not permitted.



- 1110.03 No Boat will be permitted to start in any Pro Stock Class Event unless its engine has been checked for compliance with the Pro Stock Class Regulations and sealed beforehand.
- 1110.04 Should an engine repair or rebuild be necessary before an Event and time does not allow for another measure and seal before starting, the engine must then be sealed before competing on the day and then measured in accordance with the current Rules on examining and measuring.
- 1110.05 **MODIFICATIONS:** Any modifications are to be made within the spirit of the Class and register to maintain close affordable racing.
- 1110.06 **BLOCK** – Only small block engines under 6000cc in capacity are permitted  
Only Mass-produced cast iron blocks as fitted to passenger vehicles are permitted.  
Specially cast race blocks are not permitted.
- 1110.07 **CARBURETTORS** – Up to 850cfm Holley general production carburetors with the choke horn fitted are only permitted to be used. Carburetors designed specifically for racing use are not permitted.  
Machining of the carburetor body is not permitted.
- 1110.08 **MANIFOLDS** are restricted to commercially available single or dual plane types not to exceed 182mm total plenum height, including spacer, wedge or gaskets measured from the top of the block up.
- 1110.09 **TAPPETS** – Flat tappet cams only are permitted. Mushroom lifters are not permitted.
- 1110.10 **CYLINDER HEADS** must be cast iron maintaining original valve to block angles plus or minus 1 degree. Only original valve configurations are permitted.
- 1110.11 **OIL PUMP** must remain in its original position. Dry sumps are not permitted.
- 1110.12 **ROLLER ROCKERS** must be standard ratio. Offset rockers are not permitted.
- 1110.13 **IGNITION** – Standard ignition systems are open.  
Crank trigger systems are not permitted.  
All ignition timing advance must be mechanical and operated inside the distributor.
- 1110.14 **EXHAUST SYSTEM** is free, but must meet a set noise limit of 95 decibels.
- 1110.15 **BLOWERS** or forced induction is not permitted.
- 1110.16 **CAMS:** External cam adjustments are not permitted.
- 1110.17 Only **BP ULTIMATE** commercially available automotive pump fuel is permitted to be used.

## **1111 GRAND PRIX HYDROPLANE CLASS RULES**

- 1111.01 All Boats must be fitted with a Reinforced Cockpit complying with the Rules of The Association.
- 1111.02 The Boat must be of the Hydroplane type having a minimum length of 6.4m excluding projections that are not part of the original hull.
- 1111.03 Maximum Boat size is 8.0m long by 3.81m wide and the “box style” method of measurement must be used (i.e. the Boat plus all projections must fit into a rectangular box 8 metres by 3.81 metres. Displacement and Tunnel Boats are not permitted.
- 1111.04 The minimum weight for Boats in this class is 910kg for naturally aspirated engines and 1080kg for supercharged or turbocharged engines.
- 1111.05 The weights are to be taken when the Boat finishes the Race and must include fuel remaining in the Boat, but exclude Driver and any water in the Boat.
- 1111.06 Cavitation plates and drive shafts must not be adjustable while the Boat is in motion, however wings can be.
- 1111.07 Propulsion must be by one underwater propeller. Out drives (stern drives) are not permitted.
- 1111.08 All Boats must be fitted with an onboard fire extinguishing system of at least 5kg capacity half of which must be placed in front of the engine.
- 1111.09 The system must include a manual triggering device operable by the Driver onboard or by a helper outside.
- 1111.10 The location of the device must be indicated by the letter E in a red circle.
- 1111.11 Each Boat trailer in the Pit Area must have a minimum of 3kg capacity BFC fire extinguisher available for easy access.
- 1111.11 Engines must be cast iron automotive or marine 4-cycle, 2 valves per cylinder, internal combustion type with a maximum capacity of 8.36 litres with no allowance. Superchargers and turbo chargers are permitted, without penalty.
- 1111.11 The only fuels permitted are alcohol and gasoline. Nitro or nitrous oxide is not permitted.

## **1112 BLOWN LITES DISPLACEMENT CLASS RULES**

- 1112.01 **SPECIFICATIONS** – The specifications have been kept to a minimum. The idea is to develop a close and competitive championship that will give an equal opportunity and allow driver ability and boat setup to achieve the end result. The Class is open to Boat Owners and Drivers that accept these conditions.
- 1112.02 The specifications outlined below will be overseen by a technical team and will be enforced by the technical team or a representative of the technical team.
- 1112.03 **SCRUTINEERING** – All Boats must comply with the Rules of The Association and Event regulations.
- 1112.04 Additional compliance checking will take place at all Events prior to racing. This will include bubble-testing, blowers, etc.
- 1112.05 **HULLS** – All Boats must comply with the requirements of Displacement Class Hull Rule 1102.30.
- 1112.06 Boats must be of a minimum length of 18' 1" (5.50m).
- 1112.07 Boats must have approval and certification from the manufacturer that the Boat has been checked and can accommodate the added performance.
- 1112.08 Wings are not permitted.
- 1112.09 **ENGINE – Block** – A maximum capacity of 380ci (6,227cc) is permitted. The block must be a V8 of iron construction. The manufacturer is open.
- 1112.10 **BLOWER** – GMC style standard 6/71 (max 1:1 drive) with no internal mechanical means of sealing (i.e. Teflon, Nylatron, Graphite, etc). Standard inlet/outlet. Centrally mounted over engine. The belt type is open. Three-lobe rotor. Manifold can be fabricated or cast. Intercoolers or hat spacers are not permitted. Turbochargers, screw or centrifugal blowers and hi-helix rotors are not permitted.
- 1112.11 Only an Enderle "Bug" hat is permitted with maximum 3.690" (93.73mm) x 3 butterflies and a maximum of 8 hat nozzles and 8 port nozzles. Electronic injection is not permitted.
- 1112.12 **HEADS** – Single sparkplug heads – Iron or Alloy, Valve train is open. Cam type and drive are open.
- 1112.13 **IGNITION** – Ignition is open, however single ignition unit only.
- 1112.14 **EXHAUST** – All engine water through pipes or local regulations apply. Zoomies are permitted.
- 1112.15 **FUEL PUMP** – No restrictions.
- 1112.16 **OIL** – Wet or dry sump permitted.
- 1112.17 **GEARBOX** – A ratchet-style propeller release must be fitted to an existing gearbox or a ratchet-style propeller release gearbox is to be fitted.
- 1112.18 **FUEL** – Methanol only. No fuel additives are permitted with the exception of an upper-cylinder lubricant.
- 1112.19 **APPAREL** – Fire resistant race suit, socks and balaclava must be worn.
- 1112.20 Any Boat competing in the Blown Lites Displacement Class must be fitted with a Reinforced Cockpit.

## **1113 SUPERSTOCK RESTRICTED CLASS RULES**

- 1113.01 The Superstock Restricted Class will be open to all boats both Reinforced Cockpit and Non-Reinforced Cockpit, including but not limited to: Inboard Displacement, Hydroplane, Outboard Mono and Tunnel Hulls.
- All Boats are to be subject to specific Hull Design and Safety Rules for both Inboard and Outboard, i.e. Hull Length, Maximum HP, Cockpit Requirements etc.
- 1113.02 A maximum capacity of 8,000cc is permitted. Forced induction engines are not permitted.
- 1113.03 Boats fitted with "Big Block" engines must be of a minimum length of 5.33 metres (17' 6").
- 1113.04 Boats will be restricted to a maximum speed of 105mph (169kmh). Compliance with the maximum speed may be enforced with the use of GPS equipment.
- 1113.05 Boats exceeding 105mph will be disqualified from the Race.

## **1114 SUPERSTOCK BRACKET RACING**

- 1114.1 **SUPERSTOCK BRACKET RACING**
- 1114.11 Superstock Bracket Racing will be open to all boats both Reinforced Cockpit and Non-Reinforced Cockpit, including but not limited to: Inboard Displacement, Hydroplane, Outboard Mono and Tunnel Hulls.
- All Boats are to be subject to specific Hull Design and Safety Rules for both Inboard and Outboard, i.e. Hull Length, Maximum HP, Cockpit Requirements etc.
- 1114.12 The maximum speed of Superstock Bracket Racing is 105mph (169kmh).
- 1114.13 The nominated speed of each race will be designated by the club conducting the event, this nominated speed will be in increments of 10mph. (i.e. 95mph, 85mph...45mph)
- 1114.14 Compliance with the nominated speed MUST be enforced with the use of GPS equipment.
- 1114.15 Boats exceeding the nominated speed will be disqualified from the Race.

# GROUP 1200 – OUTBOARD CLASS RULES

## 1201 GENERAL INFORMATION

## 1202 HULLS

## 1203 ENGINES

## 1204 FUEL

### 1201 GENERAL

1201.01 **CHAMPIONSHIP CLASSES and TROPHIES** – The Association will control the following Australian Championships and Special Events.

#### AUSTRALIAN CHAMPIONSHIPS

25 HP Open Hull	25 HP Racing Club Trophy
Yamato OSY 400A Open Hull	J Hudson & J Keevers Trophy
550cc Super Sports	Paul's Outboard Services Trophy
800cc Open Hull	Barry Bourke Trophy
1250cc Super Sports	Ken France Trophy
1800cc Super Sports	Kerry Rogers Memorial Trophy
2100cc Super Stock Open Hull	Association Trophy
2100cc Super Sports	Race Marine Trophy
Superstock Restricted Class	NSW State Council Trophy
2700cc Restricted 4 Carburetor Super Sports	Len Sheltrum Marine Trophy
Sports Mono & MOD VP	Blake's Marine Trophy
Formula 1	NSW Council Trophy
Formula SST120	NSW Council Trophy
Formula 3	NSW Council Trophy
Formula 4	NSW Council Trophy
Formula 2	NSW Council Trophy
Unlimited Mono Hull	Bert Hines Tennessee Boats Trophy
Unlimited Open Hull	Arch Spooner Gold Cup
Unlimited Open Inboard and Outboard	Stannard Cup

#### SPECIAL AUSTRALIAN EVENT

Unlimited Auto Engine Inboard & Unlimited Open Outboard	Riverside Trophy
---	------------------

1201.02 The Classes for Championships, Speed and Time Trials and Special Record Attempts for the ensuing season are to be ratified annually by The Association.

1201.03 The eligibility of any motor is to be ratified by The Association three (3) months before being used in competition.

1201.04 Reliability Trials are recognised as Australian and State Sanctioned Events

1201.05 The Stannard Cup Event must be conducted in accordance with the Regulations as set out in the Deed of Gift governing the Event.

1201.06 The Riverside Trophy Event must be conducted in accordance with the Regulations as set out in the Deed of Gift governing the Event.

1201.07 Drivers and Boats stepping up from their own Class into a larger capacity Class must meet the minimum requirements (hull, ages, etc.) for the Class being entered.

1201.08 Superstock Restricted Class/Superstock Bracket Racing  
See Rule 1113.01/1114.11 for this class

**1202****HULLS****1202.00 GENERAL**

1202.01 **Reinforced Cockpits** – All sponsored Boats with engines exceeding 800cc capacity must be fitted with a Reinforced Cockpit approved by The Association.

All Outboard Mono and Mod VP Boats fitted with engines exceeding 2100cc capacity and fitted with a quickfoot style gearbox must be fitted with a Reinforced Cockpit approved by The Association.

1202.02 **Hull length** - A limit applies to the motor capacity permitted to be fitted to a given length of Boat as follows:

<b>Up to 550cc</b>	<b>Unrestricted length</b>	<b>1251cc to 1800cc</b>	<b>4.0 metres</b>
<b>551cc to 800cc</b>	<b>3.35 metres</b>	<b>1801cc to 2100cc</b>	<b>4.8 metres</b>
<b>801cc to 1250cc</b>	<b>3.50 metres</b>	<b>Over 2100cc</b>	<b>5.0 metres</b>
		<b>Any engine above 220kg</b>	<b>5.5 metres</b>

1202.03 The Boat length must be measured between perpendiculars at the extreme bow and stern.

1202.04 The bow is the forward most point of the Boat meeting the main deck.

1202.05 The stern is the transom joining the extremities of the Boat and to which the motor is attached.

1202.06 Any extending parts, rubbing strakes, fenders, stabilising and trim fins are not included in the length measurement.

1202.07 Trim tabs, after planes and directional fins are permitted.

1202.08 Hydrofoils are not permitted.

1202.08 All Boats (except those classes covered under Rule 1202.09) must have a seat with a functional back fitted.

1202.09 Seats are optional in Outboard Hydroplane, 25 HP, Yamato OSY400A and 550 cc Super Sports Classes and Boats fitted with a reinforced cockpit.

1202.10 Motor height and the position of the steering and seat are optional in all Classes.

1202.11 All Boats must have floatation securely fitted or built in to assist floatation in the event of the Boat being swamped or submersed.

1202.12 Any Boat fitted with power trim must have a working trim indicator fitted in a position clearly visible to the Driver at all times.

1202.13 Boats in the 25 HP and Yamato OSY400A Classes are not permitted to have any device fitted that allows the trim angle of the motor to be altered whilst the Boat is underway.

1202.14 Tiller steering is not permitted in the 25 HP and over Classes.

**1202.20 HYDROPLANE HULL** - A hydroplane hull is one where the bottom area contacting the water is reduced at speed by a step or steps, - laterally or longitudinally - and which divide the planing area into two or more distinct planing surfaces.

1202.201 The entry of any Hydroplane class Hull in an Open Hull Class Events automatically excludes the hull from competition in any Hydroplane Event.

**1202.21 HYDROPLANE CLASSES**

<b>"C" Class</b>	<b>Motor to be not more than 500cc capacity</b>
<b>"D" Class</b>	<b>Motor to be not more than 700cc capacity</b>
<b>"F" Class</b>	<b>Motor to be not more than 1000cc capacity</b>
<b>Unlimited Class</b>	<b>Motor to be any capacity.</b>

**1202.40 MONO HULL** - Mono Hulls must not have any air tunnel, air trap, or stepped bottom. Directional fins on the underside of the Boat and considered necessary for stability are permitted.

1202.401 In questionable cases, acceptability of a given Boat is the responsibility of the Referee whose decision is final.

1202.41

**MONO HULL CLASSES**

<b>800cc Class</b>	<b>Motor capacity not to exceed 800cc</b>
<b>1250cc Class</b>	<b>Motor capacity not to exceed 1250cc</b>
<b>1800cc Class</b>	<b>Motor capacity not to exceed 1800 cc</b>
<b>2100cc Class</b>	<b>Motor capacity not to exceed 2100cc</b>
<b>Unlimited Stock Class</b>	<b>Motor not to exceed 250hp</b>
<b>Sports Mono/Mod VP</b>	
<b>Unlimited Class</b>	<b>Motor capacity unlimited</b>

1202.60

**OPEN HULL** - Any type of hull is permitted in this class

1202.61

The use of suitably constructed ballast tanks is permitted, the contents of such being considered fixed.

1202.62

**OPEN HULL CLASSES**

<b>25 HP Class</b>	<b>Motors up to 25 HP Manufacturers rating</b>
<b>Yamato OSY400A Class</b>	<b>Motor restricted to Yamato manufacture only</b>
<b>800cc Class</b>	<b>Motors up to 800cc capacity</b>
<b>1250cc Class</b>	<b>Motors up to 1250cc capacity</b>
<b>2100cc Super Stock Class</b>	<b>Motors up to 2100cc capacity</b>
<b>550cc Super Sports Class</b>	<b>Motor up to 550cc capacity</b>
<b>1250cc Super Sports Class</b>	<b>Motor up to 1250cc capacity</b>
<b>1800cc Super Sports Class</b>	<b>Motor up to 1800cc capacity</b>
<b>2100cc Super Sports Class</b>	<b>Motor up to 2100cc capacity</b>
<b>2700cc Super Sports Class</b>	<b>Motor up to 2700cc capacity restricted to up to 4 (four) carburettors</b>
<b>Unlimited Class</b>	<b>Motor capacity unlimited</b>

1202.63

**MOD VP HULL** - The diagram following represents the rear view of the profile of a typical Mod-VP Boat. Variations are permitted to this diagram provided the following specifications and dimensions are complied with.

1202.631

The centre pod (P) must be level with or lower than the outside sponsons (S) at the level line (L) for a minimum of one metre continuously.

1202.632

The centre pod must not end more than 75 mm. before the sponsons end.

1202.633

The centre pod must have a minimum width (A) of 205 mm measured at 20 mm (D) above the level line.

1202.634

The centre pod must have a maximum width (C) not to be smaller than the width (B) of the sponsons

1202.635

The length of the Boat must not be less than 5 metres.

1202.636

Mod VP Boats are exempt from Rule 1001.01.

Dimension A when taken 20mm above line L = 205 mm. (Minimum) Dimension C (width of pod at top) must be at least as large as Dimension B = sponson bottom width: Line L is the level line.

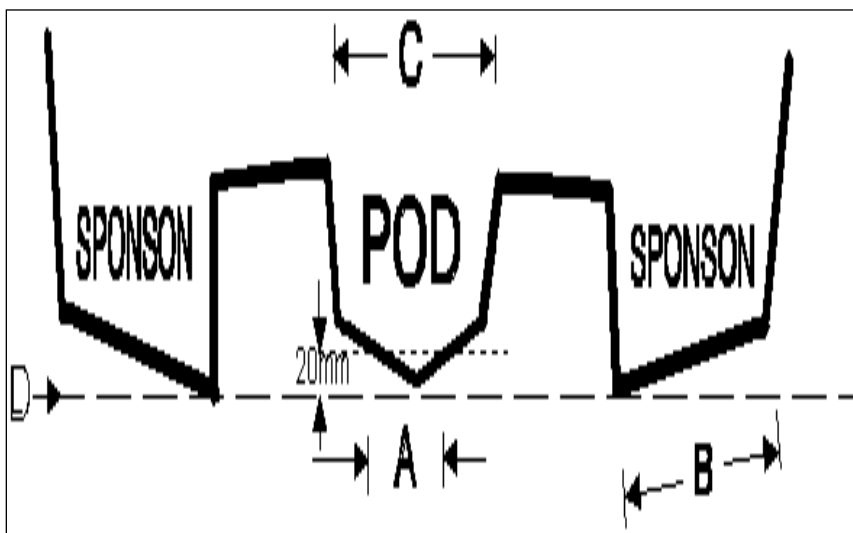

**1203****MOTORS****1203.00 GENERAL**

**1203.01 DEFINITION** - An outboard motor is a power unit / transmission unit assembly that can be lifted complete with all its accessories as a single unit from the Boat and when so removed must be capable of being started and run when connected to a fuel supply.

1203.02 Each Boat must be powered by one motor only.

1203.03 It is not permitted to replace the motor or power unit by another during a Race.

1203.04 The capacity of rotary motors must be calculated using the formula devised by CAMS for calculating the capacity of rotary motors.

1203.05 When motors are measured and sealed with an APBA seal, it is only necessary to seal the power unit.

1203.06 It is the responsibility of the Boat Owner to supply the engine measurer with the specifications for the motor being examined and measured.

1203.07 Supercharging or turbo charging is not permitted in any Outboard Class.

**1203.20 STANDARD FACTORY MOTORS** - Except in the Hydroplane, Super Sports, Super Stock, Sports Mono/Mod VP, Unlimited Capacity Mono, and Unlimited Open Hull Classes, all motors must be standard factory models that are advertised and listed in manufacturers' brochures and must be freely available for sale to the public through normal retail outlets. Motors must be designed specifically for normal recreational boating use and not "special run" or limited race models. Commercial engines are not eligible for Stock Classes.

1203.21 Except in the Hydroplane, Super Sports, Super Stock, Sports Mono/Mod VP, Unlimited Capacity Mono, and Unlimited Open Hull Classes, all motors must be fitted with standard factory gearboxes capable of forward and reverse operation at all times.

1203.22 The interchange of different manufacturer's parts or the fitting of special parts is not permitted.

1203.23 The fitting of special water 'pickup' tube or similar device fitted to either the hull or motor to direct water into or onto the motor is not permitted. Standard production water pickups and exhausts can only be used and no modifications are permitted.

1203.2401 Balancing may include the crankshaft but no extra metal is to be added to the bob weights that would result in a higher crankcase pressure.

1203.2402 Reboring to the limit foreseen by the manufacturer and within the capacity limit for the Class and provided standard oversize components available for the particular motor are used.

1203.2403 Oil Injection Systems can be rendered inoperative but only to the motor manufacturers specifications.

1203.2404 The over-speed switch can be rendered inoperable.

1203.2405 The ignition timing can be altered.

1203.2406 Carburettor jets can be substituted by genuine factory listed spare part alternatives.

1203.2407 The spark plugs can be replaced.

1203.2408 A tachometer can be fitted.

1203.2409 The thermostats can be removed.

1203.2410 A nose cone can be added to the front of the gearbox bullet and can be faired into the gearbox and leading edge of the casing above the bullet.

1203.2411 The propeller can be replaced.

1203.2412 Anti-torque devices can be added to the rear edge of the motor skeg. Any such device must not add more than 25 mm. to the width or length of the skeg.

1203.2413 The rubber mounts of the motor can be altered.

1203.2414 The steering bar and brackets and the method of attachment can be reinforced or altered as a safety measure.

1203.2415 Anti-cavitation plates on motors cannot be increased in size by more than 120mm to either side and not more than 150mm to the rear of the standard anti-cavitation plate.

**1203.30 YAMATO OSY400A Class MOTORS**

1203.31 The motor must be any Yamato model approved and homologated by UIM for racing in the OSY400 Class.

1203.32 The motor must be stock standard to the dimensions and weights as shown on the UIM Homologation Papers and repaired motor parts must conform to the standard dimension ONLY, not the plus or minus tolerance.

**1203.33 The ONLY modifications permitted are: -**

1203.331 Normal motor adjustments.

- 1203.332 The spark plugs can be replaced.
- 1203.333 The method of fuel supply.
- 1203.334 If a pressurised fuel system is fitted, the carburettor float system can be altered by using the approved factory parts only.
- 1203.335 Motor cowlings.
- 1203.336 Steering arms.
- 1203.337 Reboring to the limit provided by the manufacturer.
- 1203.34 The propeller must be the stock two bladed item as supplied with any of the approved and homologated Yamato motors. Modifications to the Stock Propeller are permitted.
- 1203.40 SPORTS MONO & MOD VP CLASS MOTORS**
- 1203.41 Externally, the motor must appear standard, as supplied by the manufacturer.
- 1203.412 Cowl scoops are not permitted.
- 1203.413 Externally refers to the motor with the engine cowling off.
- 1203.42 The maximum motor capacity is **4.5 Litres** with a limit of six (6) carburettor venturis or a manufacturer fitted fuel injection system. Slide plate style injection systems are not permitted.
- 1203.43 Turbo charging, super charging or nitrous oxide is not permitted.
- 1203.44 Internally, the engine modifications are free.
- 1203.45 Gearboxes must be through-hub exhaust type and gearbox modifications are unlimited.
- 1203.46 Motors specifically built for the USA MOD VP Classes are permitted.
- 1203.47 Exhaust relief holes can be drilled vertically.
- 1203.48 Low water pick-ups are permitted.
- 1203.49 Anti-torque devices can be added to the rear edge of the motor skeg.
- 1203.492 Extended skegs can be used for safety reasons.
- 1203.50 SUPER SPORTS CLASSES**
- 1203.51 Motors in the 550, 1250, 1800 and 2100 Classes are limited by capacity only.
- 1203.52 Motors in the 2700 class are limited to a maximum capacity of 2700cc and are limited to four (4) carburettors.
- 1203.60 HYDROPLANE CLASSES**
- 1203.61 Motors are limited by capacity only.
- 1203.70 1250cc SUPER STOCK**
- 1203.71 Motor capacity is limited to 1250cc
- 1203.72 Motor Modifications are unlimited
- 1203.73 Gearboxes must be through-hub exhaust type and gearbox modifications are unlimited
- 1203.74 Racing mid-sections and quick foot styled gearboxes are not permitted.
- 1203.80 2100cc SUPER STOCK CLASS**
- 1203.81 Engines must be production steel bore and carburettor.
- 1203.82 Gearboxes must be through-hub exhaust type and gearbox modifications are unlimited. Quickfoot style gearboxes are not permitted.
- 1203.90 UNLIMITED STOCK CLASS**
- 1203.91 Motors must be of standard factory specification with 20" mid-section and operating forward-neutral-reverse gearbox. The centreline of the propeller shaft must be a minimum of 50mm below the planing plank. Mechanical jacking plates must be disabled prior to competition and rendered inoperable to the Scrutineer's satisfaction.

## **1204 FUEL**

- 1204.00 LEADED FUELS** – The use of leaded fuels will be permitted until such time as the Federal Government or one of their agencies prohibits the use of leaded fuels.
- 1204.01 STANDARD MOTOR, YAMATO OSY400A, MOD-VP and 1250cc SUPER STOCK CLASSES** - The fuel must be commercially available grade used for automobiles and aviation. The use of methanol or other additives aimed at increasing the performance of the motor or the octane rating of the fuel is prohibited.
- 1204.02 SUPER SPORTS CLASSES and UNLIMITED MONO HULL** - There is no restriction on the type of fuel that can be used or to additives.
- 1204.03 HYDROPLANE CLASSES and UNLIMITED OPEN CLASS** - There is no restriction on the type of fuel that can be used or to additives in these classes.

- 1204.04 Non-adherence to Rules 1204.01 through to 1204.03 or the refusal to allow random samples to be taken will result in immediate disqualification from that event and prohibit the competitor from participating in any other event on that day.
- 1204.05 If a sample is found to be illegal, the competitor will be held responsible for all costs incurred in the analysis of the sample.
- 1204.06 NITROUS OXIDE** - The use of Nitrous Oxide or any other chemical supercharging is not permitted in any Class. **Chemical Supercharging shall include the use of Nitro-Methane or any fuel containing MTBE (Methyl Tertiary Butyl Ether) above the Australian Government Department of Environment and Energy standard.**

## **1205 FORMULA CLASSES**

### **1205.10 FORMULA CLASSES – HULL LENGTH AND WEIGHT**

Each boat must meet one of the following specifications, with weights to be taken at the completion of any qualifying session or race in “as finished”. The complete rig weighed directly after qualifying or race will include driver, personal safety equipment, and residual fuel but without residual water.

#### **1205.11 Formula 1**

Maximum Engine Capacity / Induction Method	Minimum Length	Minimum Weight
2.0 Litre Carburettor	5.0 metres	477kg
2.0 Litre EFI	5.0 metres	477kg
2.4 Litre Carburettor	5.0 metres	497kg
2.5 Litre Carburettor	5.0 metres	535kg
2.5 Litre EFI	5.0 metres	550kg
OMC V6 Carburettor	5.0 metres	550kg
OMC V6 EFI	5.0 metres	550kg
Yamaha V6 Carburettor	5.0 metres	550kg
Yamaha V6 EFI	5.0 metres	550kg

#### **1205.12 Formula SST120**

Maximum Engine Capacity / Induction Method	Minimum Length	Minimum Weight
SST120 – 2050cc Carburettor	4.8 metres	500 kg

#### **1205.13 Formula 3**

Maximum Engine Capacity / Induction Method	Minimum Length	Minimum Weight
1250cc Carburettor or EFI	3.5 metres	350 kg

#### **1205.14 Formula 4**

Engine / Induction Method	Minimum Length	Minimum Weight
Mercury 60 EFI Formula Race	3.9 metres	350 kg

#### **1205.15 Formula 2**

Engine Capacity / Induction Method	Minimum Length	Minimum Weight
Mercury Optimax SST200– 2526cc Direct Fuel Injection (DFI)	5.0 metres	550 kg



1205.20 FORMULA CLASSES – ENGINES AND SPECIFICATIONS

1205.21 Formula 1

Maximum Engine Capacity / Induction Method	ECU	Rev limit
2.0 Litre Carburettor	n/a	none
2.0 Litre EFI	open	none
2.4 Litre Carburettor	n/a	none
2.5 Litre Carburettor	n/a	none
2.5 Litre EFI	A10 standard fuel curve	8650 soft 9100 hard
OMC V6 Carburettor	n/a	none
OMC V6 EFI	open	8650
Yamaha V6 Carburettor	n/a	none
Yamaha V6 EFI	open	8650

1205.211 Any boat that does not meet the combinations listed in this rule but complies with all other APBA rules may apply to for a parity ruling specification and 'special' inclusion.

1205.212 A standard 4 gear/twin shaft must be used.

1205.213 All gearboxes must be weighed and marked by the scrutineers before participating in any practice session or race.

1205.214 After timed qualifying sessions and each race, the boats that placed 1st, 2nd, 3rd and 4th must report to the inspection area for any or all of the following checks:

- Weight
- Rev limit as per the table above
- Fuel
- Gearbox (Visual inspection that scrutineer mark is still on the gearbox)

1205.215 Aftermarket plug lead style tachometer can be added by the club to any boat at any time at the discretion of the committee.

These will be checked by an official as the boat exits the water.

A crew member must be available to assist official with removal of engine cowl.

This must not be tampered with by anyone other than an Official.

Failure to comply will result in disqualification.

1205.22 Formula SST120

Maximum Engine Capacity / Induction Method	ECU	Rev limit
SST120 – 2050cc maximum / Carburettor	Open	None

1205.221 For specification/modification details refer to “Formula SST120 (SST120) Specification Sheet”.

1205.222 After timed qualifying sessions and each race, the boats that placed 1st, 2nd, 3rd and 4th must report to the inspection area for any or all of the following checks:

- Weight
- Fuel

1205.223 All engines must be checked by a person nominated to ensure compliance with the SST120 rules.

1205.234 Engines may be sealed with a “holding” seal prior to racing by the appointed engine sealer (or deputy).

1205.235 The holding seal will be checked by the appointed engine sealer (or deputy) as soon as possible after the event in question and prior to any further racing with the series being permitted.

1205.236 All points for the race meeting (raced under the holding seal) will be stripped if, when the engine is checked, it is found to be not compliant with the SST120 rules.

1205.237 For technical inspection guidelines refer to “Formula SST120 (SST120) Specification Sheet”.

1205.238 Formula SST120 class boats will be subject to random compliance checking in relation to SST120 specifications at the completion of racing.

**FORMULA SST120 SPECIFICATION SHEET**

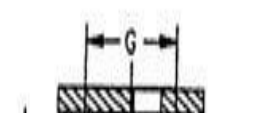
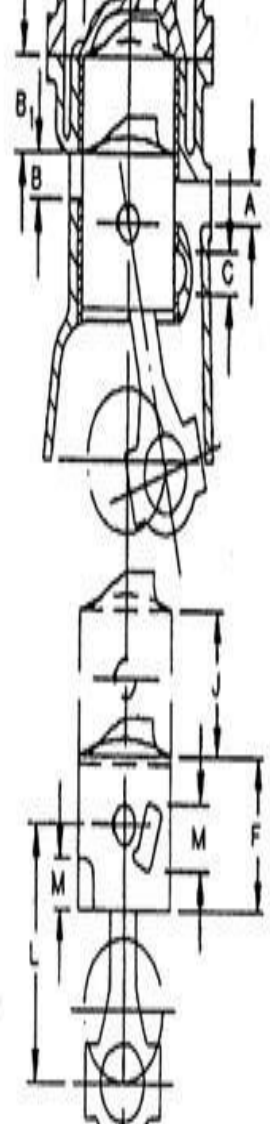
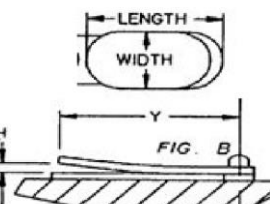
		<b>MANUFACTURER</b>			<b>MERCURY</b>	
		<b>ADVERTISED SALES NAME</b>			<b>SST-120</b>	
		<b>CLASS-DISPLACEMENT MAX</b>			<b>in3</b> <b>121.9</b>	
		<b>NUMBER OF CYLINDERS</b>			<b>6</b>	
		MIN. VOLUME OF COMBUSTION CHAMBER (INC'L SPARK PLUG HOLE)			cm3 32.0	
		VENTURI		.015	in 1.31 2	
		BORE		.015	in 1.56 2	
		QUANTITY PER ENGINE			3 DUPLEX	
	<b>PO WE RH EA D SP EC IFI CA TI ON S</b>	G	CYLINDER BORE		.003	in 3.12 5
		J	PISTON STROKE		.011	in 2.65 0
		L	ROD LENGTH		.006	in 5.50 0
		K	DECK HEIGHT		.012	in 8.31 0
		F	PISTON LENGTH		.030	in 2.80
		M	PORT HEIGHT		.030	in 2@1.03;1@0.84 4
	NUMBER OF PORTS PER CYLINDER	A	TRANSFER			3
		B	EXHAUST			1
		C	PISTON			-
	PORT HEIGHT	A	TRANSFER	.035	in	1@1.860 2@0.640
B		EXHAUST	.035	in	1.02 5	
B1		EXHAUST	.035	in	1.54 5	
C		PISTON	.035	in	-	
PORT TIMING	A	TRANSFER	2	ATC	118	
	B	EXHAUST	2	ATC	92.7	
	C	PISTON	2	ATC	--	
REED BLOCK (ONE CYLINDER)	# OF PORTS				8	
	LENGTH x WIDTH SIZE OF PORTS			MAX	in	8 Port = 1.05 x 0.63 10 Port = 1.10 x 0.56
	REED MATERIAL				ANY	
	REED THICKNESS			.001	in	ANY
	H	REED STOP HEIGHT.		MAX	in	None
	Y	CHECKING DIS.		.030	in	None
WEIGHT (ONE SET)	FLYWHEEL			MIN	lbs.	6.6
	PISTONS, RINGS, ROD, WRIST PIN, SPACERS, BEARINGS			MIN	lbs.	1.7

LENGTH x WIDTH

SIZE OF PORTS

	<b>MANUFACTURER</b>		<b>MERCURY</b>	<b>MERCURY</b>	
	<b>GEARCASE MODEL IDENTIFICATION</b>		<b>SST-120</b>	<b>SST-120</b>	
	<b>ADVERTISED SALES NAME</b>		<b>VI SSM</b>	<b>IVSSM</b>	
	<b>GEARCASE SPECIFICATIONS</b>	GEAR RATIO		14:15	15:17
		X	EXHAUST TUBE LENGTH - POWERHEAD BASE TO PRIMARY TUBE END	.25 in	9.6/10.6 SEE NOTE # 12,13
		Q	TORPEDO LENGTH (W/ PROPSHAFT)	MAX in	20.25
		R	TORPEDO WIDTH	MIN in	2.25
		S	STRUT WIDTH	MIN in	1.17
		S2	STRUT WIDTH (2" FORWARD OF TRAILING EDGE)	MIN in	
		W	DIS. FROM PROPSHAFT TO CAVITATION PLATE	.2 in	7.37
		Y	LENGTH OF SKEG FROM PROPSHAFT	.2 in	6.44
		Z	TORPEDO LENGTH	.2 in	14.88
		V	PROPSHAFT CENTRELINE TO POWERHEAD BASE	LONG SHAFT	.2 in
SHORT SHAFT				.2 in	21.84
Y1		SKEG THICKNESS	MIN in	0.20	
Y2	SKEG THICKNESS	MIN in	-		

**1. Head:**

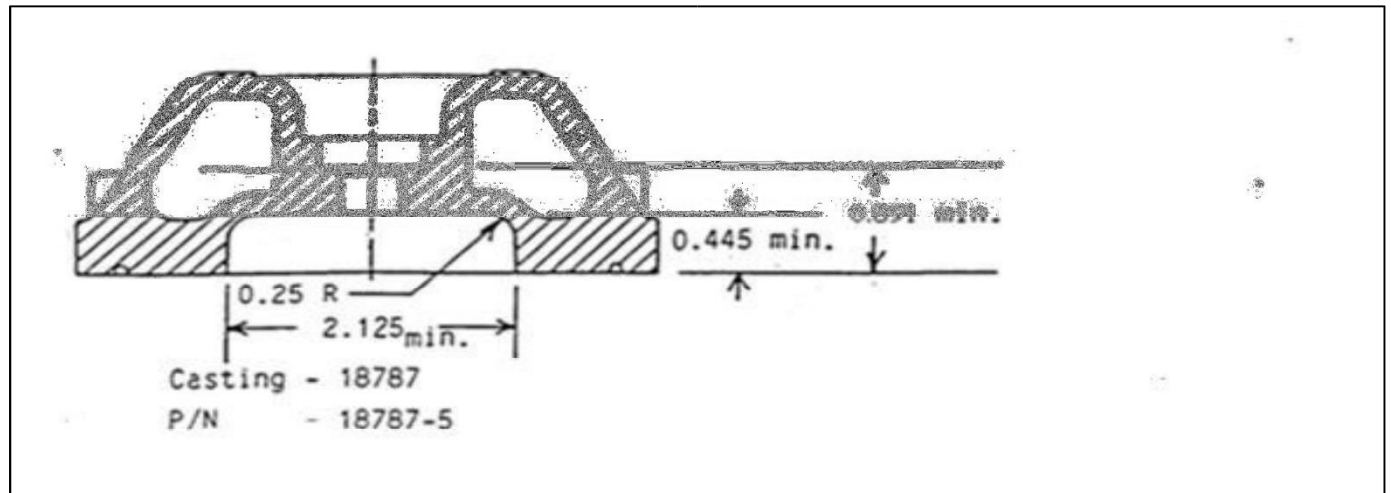

2. Head gasket thickness is .045 inches minimum.
3. Some hand de-burring may be present in V-6 rod slot areas.
4. Any drive shaft housing legal for SST-140 is legal for SST-120.
5. SST-120 must run either a 0.125 or 0.435 inch restrictor washer in both cylinder head thermostat covers.
6. All V6 crankshafts may have a chamfer at the seal ring diameter.
7. The V6 crankshaft centreline to crankcase/intake manifold surface to be 4.42\_0.01 inches. 8. Intake Manifold thickness 2.000 \_ .015. (Between carburetors and reed blocks)
9. Port timing tolerance on boost port is 3.

10. Exhaust Port Shape Template, part number 91-843116, is to be used as a gauge of the exhaust port shape. The radius at the top of the port and the corner Radii must be visible at all edges of the template when the template is placed even (line-to-line) with the top centre of the exhaust port. No part of the exhaust port may extend beyond the template
11. SST-120 exhaust port passages to the exhaust chest dimensions are as follows: 1.03 inches (width) 2.40 inches (height) max.
12. SST-120 exhaust tubes must each have one 0.50\_0.01 inch diameter hole.
13. SST 120 exhaust tube plate water dump holes: 2 holes @ 0.50+/-0.01 diameter
14. SST 120 cylinder head combustion chamber pockets may have surface refinished. The cylinder head measurements must be within specified dimensions. Welding and repairs in the combustion chamber surfaces will be permitted. The combustion chamber must remain central to the cylinder.
15. The Only Approved Aftermarket Ignition Parts are: CDI Electronics (RaPair) only parts made by CDI to replace the OEM part number may be used.
16. **SST-120 Ports:**

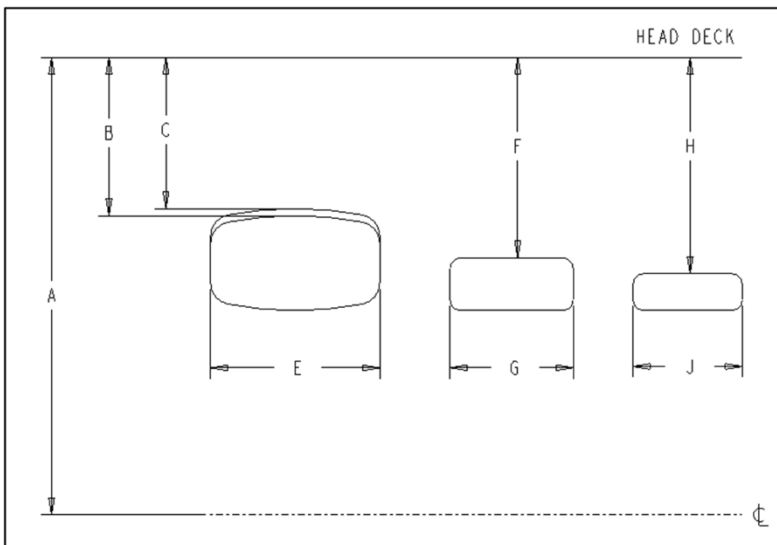

Port Measurements from Block Top Deck down to Top of Port

	SST120	Minimum Inches	Maximum Inches
A	Deck Height	8.298	8.322
B	Exhaust Port	1.530	as cast
C	Exhaust Port Chamfer	1.510	1.565
E	Exhaust Width		as cast
F	Transfer Port	2.04	
G	Transfer Port Width		as cast
H	Boost Port	2.02	
J	Boost Port Width		as cast

17. All engines must fall between the specified dimensions listed on this sheet.
18. The APBA modifications allowable in Rule 1203.20 – STANDARD FACTORY MOTORS do not apply.
19. Cowling and engine graphics may be of any design
20. Engine wiring can be changed to allow for 24-volt starting system
22. Gear cases may have their surfaces refinished.
23. The engine primer system may be removed or rendered inoperable.
24. Reed valves can be substituted for any material or design.
25. No specially made or interchange parts will be permitted.
26. SST-120 cylinders bored to +0.030 inches oversize must have boost and exhaust port heights that measure .015 inches lower than a standard bore engine.
27. Only Mercury SST120 engines are eligible for Formula SST120.
28. Maximum engine displacement 2050cc.
29. Exhaust tuners used must be standard, as supplied by the manufacturer.
30. Gear cases may have their outside surfaces re-profiled however; they must meet the minimum dimensional requirements of the Specification Sheet.
31. Tachometer, fuel and water pressure, and temperature (including EGT) gauges can be installed if desired.
32. Any propeller may be used. Providing the gear case is not modified to accommodate a propeller.
33. Replacement products cannot provide any performance advantage over original OEM parts.
34. In the event of any part becoming no longer available from the engine manufacturer aftermarket parts should be approved by the committee prior to the event and being used.
35. The bore of the engine can be enlarged by the amount that the oversize pistons differ from the standard size pistons.
36. An additional total 0.005-inch enlargement of the bore will be permitted for bore enlargement due to wear or re-matching errors, or measuring tolerance.
37. Under no circumstances may the bore be enlarged more than 0.035 inches over the original dimension.

38. It is not permissible to chromium plate cylinder walls.
39. The attachment of a power trim system can be accomplished at any point or points on an engine.
40. Bead blasting will be permitted at the block and crankcase interface only.
41. No other internal parts will be permitted to be bead blasted.
42. No boat is to leave the pit area after the race meeting has commenced, until the completion of the tech inspection following the final race of the meeting.

#### 1205.23 – Formula 3

Maximum Engine Capacity / Induction Method	ECU	Rev limit
1250cc maximum / Carburettor or EFI	Open	None

1205.231 Formula 3 class rules are as per the APBA 1250 Super Sports class rules with the exception of the rules listed in these rules in relation to weight and fuel.

1205.232 Any boat that does not meet the class specifications is not eligible for points.

1205.233 Boats that do not meet the class specifications can however nominate to enter the event, but must start at the back of the field and the driver must not interfere with racing of bonafide class competitors.

1205.234 After timed qualifying sessions and each race, the boats that placed 1st, 2nd, 3rd and 4<sup>th</sup> must report to the inspection area for any or all of the following checks:

- Weight
- Fuel

#### 1205.24 – Formula 4

Engine	ECU	Rev limit
Mercury 60 EFI Formula Race	As supplied by the manufacturer	6200

1205.241 After timed qualifying sessions and each race, the boats that placed 1st, 2nd, 3rd and 4<sup>th</sup> must report to the inspection area for any or all of the following checks:

- Weight
- Fuel

#### 1205.243 FORMULA 4 ENGINE SPECIFICATIONS

1. The Mercury 60 EFI Formula Race engine with 15" midsection is the only UIM homologated engine to be used in the class. This engine must conform to the 2006 EPA regulations.
2. Motor Height as per UIM Rule (see attached diagram)
3. The engine, electrical and fuel systems must be standard as supplied by the manufacturer.
4. 24-volt electrical systems are not permitted.
5. When the motor is in the water, the cooling must be effected by the homologated water circulation pump.
6. An efficient gear changing system giving forward, neutral and reverse movement is compulsory. The control handle for reverse gear, ready for use, must be within easy hand-reach of the driver when he/she is in the normal driving position. Manoeuvring of the boat astern must be possible by selecting reverse gear.
7. The casing of the underwater unit (gear case) is free. All internal parts referred to on the homologation file must be maintained.
8. The exhaust will be a propeller exhaust.
9. All lower unit exhaust openings must remain standard within the homologated size.
10. An electric starter must assure a quick and easy start without external aids. It must be used as it was supplied by the manufacturer with no adjustment or alteration being permitted.
11. Engines are required to have the computer control system checked by an APBA Engine Measurer.
12. The Manufacturers standard water pick-up is permitted.
13. Only the following modifications are permitted.
  - a. All studs, screws, nuts, bolts and their washers are free as well as the method of locking them;
  - b. The original propeller may be replaced by another. Gear cases with a propeller exhaust must use propellers equipped with an exhaust tube of a diameter at least that of the machined recess into which the standard propeller boss fits at the rear of the gear case. The length of this tube must be at least 1/2 (Q-P), where Q and P are the dimensions shown on the sketch of the underwater unit on the homologation file;
  - c. The trim tab may be altered or removed to accommodate a propeller;

- d. The cooling must be provided by the water pump;
  - e. Thermostats and pressure valves of the cooling system may be removed;
  - f. The steering mechanism may be altered. If the original steering bar is removed or new ones are installed, any openings created must be sealed to prevent the motor from pulling in additional air;
  - g. The swivel bracket may be altered for the purpose of installing a power trim and the dampers (shock absorbers) may be altered or removed;
  - h. The rubber mounts of the motor may be altered, removed or replaced;
  - i. Revolution counters, water temperature gauges, water pressure gauges and similar instruments, can be installed;
  - j. The gear interlock device on the starter may be removed;
  - k. Spark plugs are free;
  - l. Original carburettor jets may be replaced for another size;
  - m. Springs may be added to the throttle lever of the carburettors;
  - n. Reboring is allowed, but only piston assemblies supplied by the manufacturer of the motor may be used within the cc limit of the class. When ports in cylinders are adjusted to the dimensions specified in the homologation sheet, material may only be removed in the specified opening to a depth of 10 mm, to match the shape of the original adjacent connecting passage (channel) outside the adjusted port opening. This also applies to other openings in the motor for which the dimensions are specified in the homologation sheet;
  - o. A part which is dimensioned in the homologation sheet may be machined for the purpose of reaching that specific measure.
  - p. A part maybe machined to attain the weight quoted in the homologation sheet without altering other criteria given for the part in question. It is not allowed to change the flywheel but balancing machining is allowed if the dimensions and weights provided for on the homologation sheet are respected;
  - q. Measurements not quoted in the homologation sheet shall only be checked by visual comparison with standard parts. As the actual manufacturing tolerances are not published, small differences between the inspected part and the reference part must be accepted.
  - r. The fuel connector in the lower cover may be removed and the fuel hose from the fuel tank connected directly to the fuel pump. If this is done the opening left after the connector and around the fuel hose .must be sealed to prevent extra air entering inside of cover;
  - s. Electric fuel pumps may be added provided the fuel still runs through the original fuel system and no parts are removed or blocked off;
  - t. No parts may be added to the motor unless specified in this rule
14. Blueprinting of the power head is not permitted.
15. Alteration or removal of any power head components is not permitted.
16. Electrical components and control system performance must remain standard.

# ART.543.09 point 7 EXPLANATORY DRAWINGS

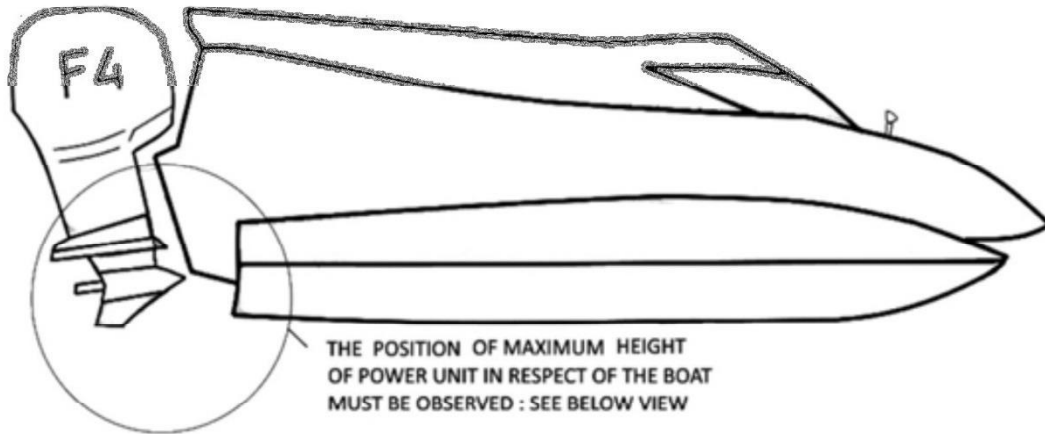

## SIDE VIEW OF THE BOAT

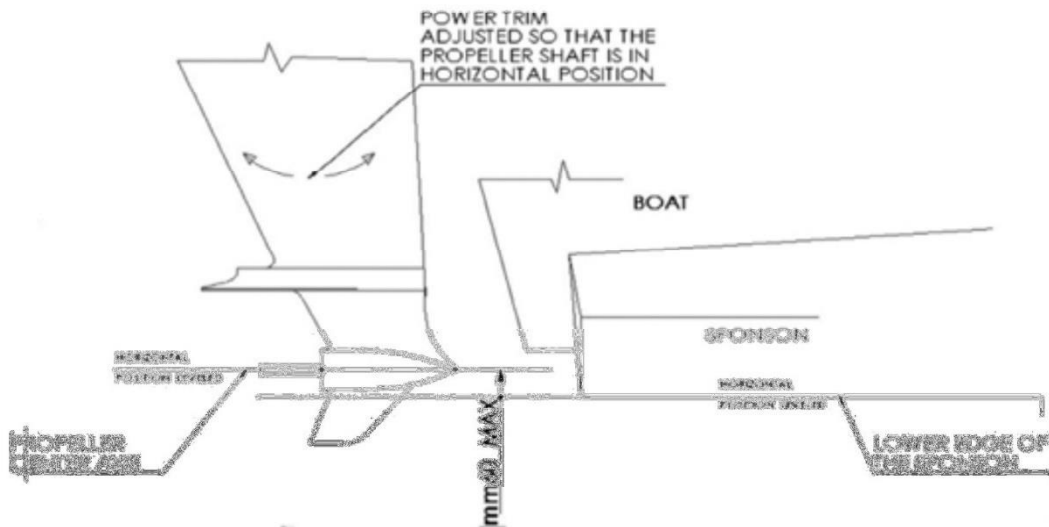

## VIEW FROM BEHIND OF THE BOAT

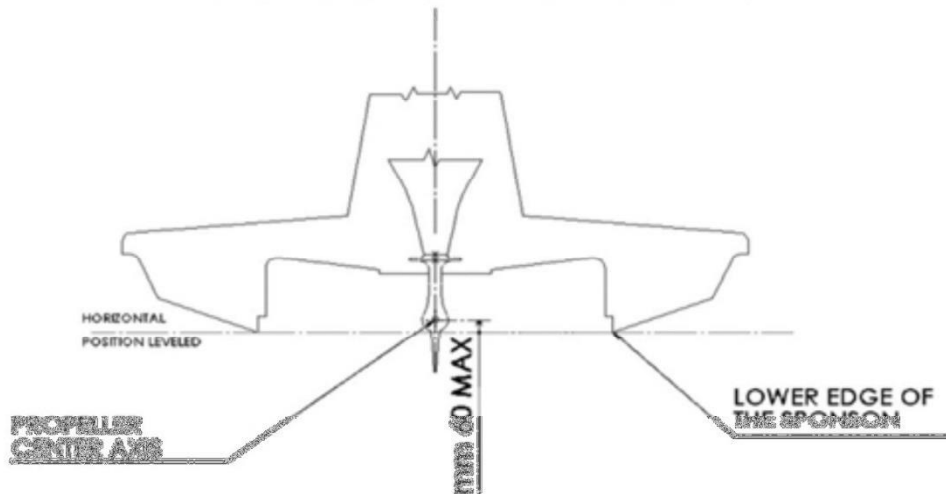

<b>Engine</b>	<b>ECU</b>	<b>Rev limit</b>
Mercury Optimax SST200– 2526cc	As supplied by the manufacturer	8650

- 1205.251 Only engines qualifying to the SST200 rules will be eligible for Formula 2.
- 1205.252 Engines will be measured and checked against the SST200 data sheets as supplied by the engine manufacturer (UIM Homologation file numbers 00501b and 00501c).
- 1205.253 All engines must be checked by a person nominated by the AFPGP to ensure compliance with the SST200 rules.
- 1205.254 Engines may be sealed with a “holding” seal prior to racing by the appointed engine sealer (or deputy). The holding seal will be checked by the appointed engine sealer (or deputy) as soon as possible after the event in question and prior to any further racing with the series being permitted.
- 1205.255 All points for the race meeting (raced under the holding seal) will be stripped if, when the engine is checked, it is found to be not compliant with the SST200 rules.
- 1205.256 For technical inspection guidelines refer to **1205.259 – Engine Specifications**
- 1205.257 Formula 2 class boats will be subject to random compliance checking in relation to SST200 specifications at the completion of racing.
- 1205.258 After timed qualifying sessions and each race, the boats that placed 1st, 2nd, 3rd and 4<sup>th</sup> must report to the inspection area for any or all of the following checks:
- Weight
  - Fuel

#### **1205.259 - FORMULA 2 ENGINE SPECIFICATIONS**

1. Maximum engine displacement 2526cc.
2. All cowling and engine graphics and colours will be as OEM, with updating to later models allowed only as a complete OEM design. Replacements to fibreglass cowlings are allowed as long as weights are equal to or greater than OEM models.
3. Engine wiring cannot be changed to a 24-volt starting system. Trim can be altered to a 24-volt system.
4. Gear cases may have their outside surfaces re-profiled however; they must meet the minimum dimensional requirements of the Engine Specification sheets. The outside surfaces of the gear cases can be either painted or unpainted. If they are painted, the colour of the paint must be the same as the original factory motor colour. If the gear cases are unpainted, any surface finish is acceptable.
5. A maximum of three damaged cylinders can be re-sleeved using sleeves from any manufacturer. Sleeve material and the machined port opening's shape and dimensions must all be as original equipment.
6. Reed valves as per homologation file number 00501b.
7. A manufacturer of outboard motors for Formula 2 racing is the one who filed specifications and is responsible for the original design and manufacture of the following: crankshaft, connecting rod, cylinder head, cylinder, crankcase, gears and valving arrangement, and who complied with such other requirements as provided by these rules.
8. Motors must be the product of a recognised manufacturer engaged in the production of outboard motors offered for sale to the general public.
9. The intention is to race the engine exactly as manufactured and without special performance boosting accessories.
10. No special parts or interchange of parts will be permitted, unless approved by the conducting club to the National Vice President Outboards.
11. Electronic engine RPM limiting devices cannot be over-ridden.
12. Engines (Outboard) as referred to in these rules will be defined as outboard models which:
  - Are manufactured in annual or model year quantities of more than 25 units
  - Are not necessarily intended for sale and to be used by the general non-racing public
  - Are not necessarily advertised through the same media, in the same publications and given the same prominence as the manufacturer's other engines
  - Are not necessarily distributed through the manufacturer's normal channel
  - Accessory gear case, as submitted by the manufacturer, can be used in these engines provided that they are built in a total quantity of no less than 25.
13. Standard exhaust tuners used must be as supplied by the manufacturer. Exhaust stacks not contained in the drive shaft housing will not be permitted. As per homologation papers 00501c part number 8m0053611.



- Engines may only be run in the configuration that they were homologated by the UIM and as set out in the homologation papers supplied by the manufacturer.

#### **1205.2510 - REPLACEMENT PARTS**

- Only such parts will be permitted as are standard production OEM parts used on the motor as the purchaser may obtain it from the dealer as a stock item or electrical or electronic products as approved by the conducting club or APBA, and published and available to the general public through dealers. These products cannot provide any performance advantage over original OEM parts.
- No replacement part for current production motors will be considered standard production until this part appears on current production motors that can be purchased from the dealers.
- Any replacement part for motors no longer in production will be approved only after the part being replaced is no longer available for the motor model from the manufacturer or is specifically approved by the conducting club or APBA.
- Final approval of non-OEM electrical or electronic parts for use in Formula 2 racing will not be given until all provisions of the rule have been complied with, and until such time as the manufacturers have built at least 250 units of the part submitted for homologation.
- For non-OEM electrical or electronic parts, the manufacturer must follow the same process as followed for motor manufacturer registration with respect to submission of specifications to the conducting club and APBA.
- Older style 12 inch mid sections will be allowed.

#### **1205.2511 – MOTOR MODIFICATIONS**

- There will be no blueprinting or modifications whatsoever to the motor as furnished by the manufacturer.
- Only such parts will be permitted for use as are used by the motor manufacturer on the particular model as built on the production line. Modifications covered by a manufacturer's service or engineering bulletins are legal seven days after the date of any such bulletin and approval by the conducting club or APBA, provided all direct purchasers of affected engines are notified by mail as well as all inspectors. In the event the manufacturer is unwilling or unable to meet these criteria, modifications covered in such bulletins will be legal after notification by the conducting Club or APBA.
- Oversize pistons furnished by the manufacturer of an outboard motor can be used in the model for which they are furnished.
  - The bore of the engine can be enlarged by the amount that the oversize pistons differ from the standard size pistons.
  - An additional total 0.005-inch enlargement of the bore will be permitted for bore enlargement due to wear or re-matching errors, or measuring tolerance.
  - Under no circumstances may the bore be enlarged more than 0.035 inches over the original dimension.
  - It is not permissible to chromium plate cylinder walls unless the motor manufacturer uses chrome plating of cylinder walls as standard production procedure on that particular model.
  - Tachometer, fuel and water pressure, and temperature (including EGT) gauges can be installed if desired.
- The attachment of a steering bar or its equivalent can be accomplished at any point or points on an engine. Any cowlings or plates removed can be cut and, must be replaced. Any openings created by this operation must be sealed to prevent the engines from pulling in air. Studs or bolts can be exchanged to secure steering bar.
- Throttle return springs will be permitted on engines, however no modifications to the engine will be permitted to install same; no drilling of holes, etc. Mounting links can be attached with present fasteners.
- Isolation Mounts: Only those supplied by the engine manufacturer as original equipment or through the service group are acceptable.
- Any adjustments of throttle and shift linkage will be permitted.
- No mechanical adjustments of spark advance will be permitted provided no modifications are made either to the spark advance system or to the engine as manufactured.
- Safety tilt switches and safety starting switches can be disconnected or by-passed.
- Fuel pumps, heat exchangers, swirl pots or auxiliary tanks cannot be installed. Only inline filters will be allowed.

#### **1205.30 FORMULA CLASSES – FUEL**

- 1205.31 Fuels must be commercially available street-legal grade automotive or aviation pump fuel only with no additives other than oil for engine lubrication permitted.
- 1205.32 No additives pre mixed in oil are acceptable.

- 1205.33 **Formula SST120 Class** – Only service station pump fuel or avgas is permitted. E85 or street legal 98 fuels (e.g. “VP” race fuel or “ELF” etc.) are not permitted to be used.
- 1205.34 **Formula 4 Class** – The use of additives aimed at increasing the performance of the engine or boosting the octane rating of the fuel are not permitted.
- 1205.35 Refuelling and/or the addition of any materials that affect the weight of the boat cannot be done during heats or before the inspection process, which follows the completion of a heat.
- 1205.36 Each boat and motor will be permitted only one system for the storage and/or delivery of fuel. Secondary or alternative fuel storage and/or delivery devices are strictly illegal regardless of their fuel content or capability for use.
- 1205.37 **NO** fuel is to be added to any boat during any race or during a race stoppage.

**1205.38 Fuel Testing**

- 1205.381 Fuel testing and fuel system inspection can be done at any time, before, during or after any heat of racing or qualifying session.
- 1205.382 The entire fuel system can be disassembled, removed from the boat and inspected.
- 1205.383 The presence of illegal fuel, at any time, in the on-board fuel system will be considered a violation of the fuel rules. Results of fuel testing will be final.
- 1205.384 Non-adherence to Rules 1205.381 through to 1205.383 or the refusal to allow random samples to be taken will result in immediate disqualification from that event and prohibit the competitor from participating in any other event on that day.
- 1205.385 If results of fuel testing are irregular, the driver may elect to have a sample collected by an official and sent to an independent laboratory for analysis at the driver’s expense.
- 1205.386 **NITROUS OXIDE** - The use of Nitrous Oxide or any other chemical supercharging is not permitted in any Formula Class. Chemical Supercharging shall include the use of Nitro-Methane or any fuel containing MTBE (Methyl Tertiary Butyl Ether) above the Australian Government Department of Environment and Energy standard.

## **GROUP 1300 – DRAG CLASS RULES**

**THESE RULES HAVE BEEN REMOVED FROM THE RULE BOOK  
HOWEVER, THEY CAN BE FOUND AT: [www.ausapba.com.au](http://www.ausapba.com.au)**

## **GROUP 1400 – OFFSHORE RULES**

- 1401.00 The specific rules of Offshore Powerboat Racing (Offshore Rules) are set, collated, and administered by the Australian Power Boat Association Offshore Council and are complimentary to the rules of the Australian Power Boat Association.
- 1402.00 All boats, drivers and events must comply with both the rules of the Australian Power Boat Association and the Offshore Rules.
- 1403.00 Where there is a conflict between the rules of the Australian Power Boat Association and the Offshore Rules, the Australian Power Boat Association rule is to take precedence.
- 1404.00 The Offshore Rules must be submitted annually to the Australian Power Boat Association for the records of the Australian Power Boat Association.
- 1405.00 **The Offshore Council appointed Race Director is recognised as having the authority to submit the equivalent Referee reports and results for the purposes of Australian Championship ratification**

## **GROUP 1500 – CRUISER CLASS RULES**

**THESE RULES HAVE BEEN REMOVED FROM THE RULE BOOK  
HOWEVER, THEY CAN BE FOUND AT: [www.ausapba.com.au](http://www.ausapba.com.au)**

# GROUP 1600 – FORMULA FUTURE RULES

- 1601 CHAMPIONSHIPS
- 1602 GENERAL
- 1603 BOAT
- 1604 MOTOR
- 1605 SAFETY REQUIREMENTS
- 1606 RACING FORMAT
- 1607 CHAMPIONSHIP RACING FORMAT

## 1601 CHAMPIONSHIP and TROPHY

1601.00 The Association will control the following Formula Future Class Championships:

<b>Formula Future J1 Class</b>	C D and L Trophy
<b>Formula Future J2 Class</b>	Mack Kennedy Trophy
<b>Formula Future J3 Class</b>	Gordon Atkinson Trophy

1601.01 The National Council will allocate the Championships to the Council with the greatest number of Formula Future Drivers from the previous season.

## 1602 GENERAL

1602.01 **Formula Future J1 Class** – Drivers in this Class must be aged eight to sixteen years.

1602.02 **Formula Future J2 Class** – Drivers in this Class must be aged ten to sixteen years. It is desirable that Drivers in this Class obtain, if available, a State Boat Authority Young Adult Licence (or equivalent).

Formula Future J1 Class Drivers, stepping up must meet the minimum age requirement for the J2 class.

1602.03 **Formula Future J3 Class** – Drivers in this Class must be aged twelve to sixteen years. It is desirable that Drivers in this Class obtain, if available, a State Boat Authority Young Adult Licence (or equivalent).

Formula Future Class J1 & J2 drivers stepping up must meet the minimum age requirement for the J3 Class.

1602.04 Formula Future Drivers must be members of a Club.

1602.05 The holder of a Formula Future Class Racing Licence is not permitted to enter other than Formula Future Class Events.

1602.06 Formula Future Drivers must attend a Briefing at each Event.

1602.07 A Driver of Boat must not receive physical outside assistance during the running of a Race, except in the case of an accident.

## 1603 BOAT

1603.01 **Formula Future J1 Class** – There is no restriction on the design or the length of the Boat. Where required by the State Boating Authorities, the Boat Owner must register the Boat.

1603.02 **Formula Future J2 Class** – The Boat must be a minimum of 2.5 metres in length and the design of the Boat is unrestricted. Where required by the State Boating Authorities, the Boat Owner must register the Boat.

J1 Class Boats using 6hp engines and stepping up to the J2 Class must meet the minimum requirements of their own Class regarding hulls.

1603.03 **Formula Future J3 Class** – The Boat must be a minimum of 2.5 metres in length and the design of the Boat is unrestricted. Where required by the State Boating Authorities, the Boat Owner must register the Boat.

J1 Class boats using 6hp engines and J2 Class boats using 10hp engines stepping up to the J3 Class must meet the minimum requirements of their own Class regarding hulls.

1603.04 Race numbers on Formula Future Class Boats must be a minimum of 150 mm high. Numbers must be of a colour that clearly contrasts from the background.

- 1603.05 Any device that will allow adjustment to the trim of the motor, while the boat is in motion is not permitted in any Formula Future Class.
- 1603.06 Anti-cavitation plates on motors cannot be increased in size more than 120mm to either side and not more than 150mm to the rear of the standard anti-cavitation plate.
- 1603.07 All Formula Future hulls must have floatation securely fitted or built in to assist floatation in the event of the hull being swamped or submersed.

#### **1604 MOTOR**

- 1604.01 All Outboard motors must meet the requirements for a standard motor. Only the modifications listed in Specific Outboard Rules 1203.00 to 1203.2414 will be permitted.
- 1604.02 Conversion kits are permitted but must be kits specifically released by the original manufacturer as a part designed to specifically restrict the output of the motor to no more than the maximum horsepower permitted in the class entered (see Rules 1604.05 to 1604.07).
- 1604.03 Purpose built motors, production race motors or "hotted up" motors are not permitted in any Formula Future Class.
- 1604.04 All Outboard motors in Formula Future Class racing are required to be sealed by a Measurer. The Measurement Certificate should then be presented at each Championship Event when scrutineered.
- 1604.05 **J1 Class** - The power of both inboard and outboard motors used in this Class is limited to 6hp
- 1604.06 **J2 Class** - The power of both inboard and outboard motors used in this Class is limited to 10hp.
- 1604.07 **J3 Class** - The power of both inboard and outboard motors used in this Class is limited to 15hp.
- 1604.08 **FUEL** – Fuels must be commercially available unleaded fuel.

#### **1605 SAFETY REQUIREMENTS**

- 1605.01 All Drivers must wear the Drivers apparel as described in Rules 801.01, 801.03, 801.05 and 801.06
- 1605.02 All Formula Future Drivers must wear a Helmet as described in Rule 801.02.and helmet restraints as described in Rule 801.03 and 801.04.
- 1605.03 All Formula Future hulls must have floatation securely fitted or built in to assist floatation in the event of the hull being swamped or submersed.
- 1605.04 All Formula Future Drivers must meet the requirements of Rule Section 802 - EQUIPMENT FOR DRIVERS PROTECTION.
- 1605.05 Formula Future J3 Class - A returnable spring-loaded foot throttle must be fitted. No tiller steering will be permitted.
- 1605.06 All outboard motors must be clamped and bolted to the transom and clamps secured with locking wire.

#### **1606 RACING FORMAT**

- 1606.01 All Formula Future Racing is to be conducted under handicap racing conditions.
- 1606.02 The length of the course is to be between 600 and 800 metres.
- 1606.03 The number of laps per race is to be three (3).
- 1606.04 The number of Boats starting in a race is to be at the discretion of the Officer of the Day.

#### **1607 CHAMPIONSHIP RACING FORMAT**

- 1607.01 All Boats entering Championships must do so in accordance with Group 200 Rules.
- 1607.02 All Boats entered for Championships must establish a course time from which a starting handicap is determined.
- 1607.03 The course time can be established from the average lap time of three laps established by each Boat completing either (a) three laps or (b) a three-lap 'zero' handicap race in which a number of Boats compete.
- 1607.04 Boats finishing more than 2 seconds before their handicap time are relegated to the next available place after other legitimate finishers.  
In case of more than one Boat breaking time, places are in order of closest to their handicap time.
- 1607.05 The Championship winner will be the Boat with the highest point score after three Races of handicap racing.
- 1607.06 If more Boats than that can safely run the course have entered, the number of starters in the final Races is to be determined by conducting elimination races. The predetermined number of Boats scoring the highest points will contest the final Races.
- 1607.07 Points are to be awarded in accordance with the standard points score table (Rule 908).
- 1607.08 Should two or more Boats score equal points, the Championship is to be awarded to the Boat having the lesser time when the differences in times between individual Race times and the original course time over the three final Races are totalled.

- 1607.09 Should a tie still exist; the Championship is to be awarded to the Boat having the lesser time when the differences in times between the individual elimination race times and the original course time over the elimination Races are totalled.

## **GROUP 1700 – INFLATABLE CLASS RULES**

**THESE RULES HAVE BEEN REMOVED FROM THE RULE BOOK  
HOWEVER, THEY CAN BE FOUND AT: [www.ausapba.com.au](http://www.ausapba.com.au)**

## **GROUP 1800 – VINTAGE/VETERAN RULES**

- 1801 DEFINITIONS**
- 1802 STATIC (ON LAND ONLY) DISPLAY**
- 1803 ON WATER DISPLAY**
- 1804 SAFETY REQUIREMENTS**

### **1801 DEFINITIONS**

- 1801.1** A **VINTAGE** Boat is described as a timber boat. Replica boats meet the requirements of this definition provided the appearance, construction materials, and engine are representative of the era of the boat.
- 1801.2** A **VETERAN** boat is a fibreglass or composite constructed boat that may be ineligible to race due to rule and regulation changes.
- 1801.3** Any boat entered or participating as a Vintage or Veteran Boat is prohibited from racing at the same meeting or event.
- 1801.4** Boats fitted with enclosed reinforced cockpits are not eligible.
- 1801.5** Forced induction is permitted provided it is of the era that the boat represents.

### **1802 STATIC (ON LAND ONLY) DISPLAY**

- 1802.1** Boat owners doing static (on land) displays only are not required to be Licenced by the APBA.
- 1802.2** Static displayed boats are not required to be scrutineered.
- 1802.3** Owners providing a boat for a static display must register with the event organisers.
- 1802.4** Any Boat on a Static display must not start the engine without the express approval of the event organiser or Officer of the Day. If the engine is to be started, RULE 804.08 applies.
- 1802.5** It is in the best interest of the boat owner and for the information of the public that any boat on Static Display has a billboard or A-frame showing details of the boat and its history.
- 1802.6** Any boat registered for a Static Display **MUST NOT** be put on the water.

### **1803 ON WATER DISPLAY**

- 1803.1** All boats doing on-water displays or demonstration runs must be scrutineered before launching using the standard scrutineering form. Drivers of such boats are required to be licenced by the APBA with a Vintage & Veteran Licence. The Annual Fee for a Vintage & Veteran Licence will be set at \$100 (one hundred dollars) in **2022/23** and reviewed annually. This fee to be payable to the relevant State Council
- 1803.2** All runs on the water are restricted to Demonstration Runs Only. No racing is permitted, and no start boat starts are permitted.
- 1803.3** There shall be a maximum of **6 (six)** boats on the course at any time one and the OD shall ensure that these boats are of the same or similar class (i.e. Inboard displacement, inboard hydroplane, outboard, offshore.) The OD may reduce the number of boats on the course at any one time due to prevailing conditions or size of course.
- 1803.4** A riding passenger or mechanic is only permitted to be carried aboard boats of the era. (i.e. Twin cockpit and inboard service runabouts, offshore race boats)
- 1803.5** All on water displays and demonstration runs are limited to 105mph. In this regard all boats capable of speeds in excess of 100mph are to carry a GPS on board that shall be checked by

Officials at the completion of each on water run. Drivers exceeding the 105mph limit shall be issued a warning the first time. If exceeding the 105mph limit a second time the boat is to remain on the trailer for the rest of the day/meeting.

1803.6 The rescue and patrol boats including divers and paramedics must be provided on the course as per APBA Rules.

1803.7 Flags to be used to control the on-water runs shall be as follows:

o WHITE FLAG – Boats may proceed out onto the course

o GREEN FLAG – On-water demonstration runs are in progress.

No additional boats are to enter the course.

o BLACK FLAG – Return to shore. Demonstration runs finished

o RED FLAG – Stop immediately. Danger on the course

o WHITE/RED CROSS – Continue with Caution. Boat stopped on course

## **1804**

### **SAFETY REQUIREMENTS**

1804.1 The APBA Group 800 Safety Rules and the following safety matters apply to boats being put on the water. Boats not exceeding 75mph are exempt from Rules 804.21 and 804.26

1804.2 All boats must be registered with the relevant waterways authority and must display the registration label fixed to the boat

1804.3 Seat belts are NOT permitted but lap sash belts as per APBA rules are permitted.

END